

<h2>VERIFICATION REPORT</h2> <h3>The requirement on Grid Connection of Provincial Electricity Authority B.E. 2559 (2016)</h3>	
Report No.....	: 162/63-157
EUT No.....	: SC-63-0134
Laboratory Name	: Electrical and Electronic Products Testing Center
Address	: 141 Thailand Science Park, Innovation Cluster 2 Tower D, Phahonyothin Rd., Khlong Nueng, Khlong Luang, Pathum Thani 12120, Thailand
Applicant's Name	: Shenzhen SOFAR SOLAR Co., Ltd.
Address	: 401, Building 4, AnTongDa Industrial Park, District 68, XingDong Community, XinAn Street, BaoAn District, Shenzhen, China.
Test specification	
Standard	: The requirement on Grid Connection of Provincial Electricity Authority Thailand B.E. 2559 (2016)
Non-standard test method	: -
Test item description	
Standard	: Solar Grid-tied inverter
Trademark	: 
Model and/or type reference	: HYD 10KTL-3PH
Date of receipt.....	: 10 August 2020
Date of report issue	: 13 August 2020

Prepare by



Eakkachai Taesanoo
Engineer

Approved by



Ruengrit Ninai
Operation Manager

This test report is test results from the EUT only, not the product's quality certificate. It shall not be reproduced except in full without the written approval by PTEC.

Detail of reference test report	
Test Report No..... :	PVTH200320N031
Total number of pages..... :	63
Testing Laboratory	Bureau Veritas Shenzhen Co., Ltd. Dongguan Branch No. 34, Chenwulu Section, Guantai Rd., Houjie Town, Dongguan City, Guangdong 523942, China
Testing location..... :	Bureau Veritas Shenzhen Co., Ltd. Dongguan Branch No. 34, Chenwulu Section, Guantai Rd., Houjie Town, Dongguan City, Guangdong 523942, China
Test specification	IEC 61727:2004, IEC 62116:2008, Deviations for Thailand according the grid-connected inverter regulations of the Provincial Electricity Authority (PEA:2016)
Tested by	Lukes Zhang
Reviewed by	-
Approved by	James Huang
Date of report issue..... :	2020-07-07

Test item description	Solar Inverter
Trademark	SOFAR SOLAR
Model and/or type reference	HYD 10KTL-3PH
Rating	
Input DC MPP voltage range [V]:	220-850
Input DC voltage Max [V]..... :	960
Input DC current [A]..... :	Max. 25.0 x 2
Output AC voltage [V]..... :	3/N/PE, 380/400,50Hz
Output AC current [A]..... :	Max. 16
Output power [VA]..... :	10000
Firmware Version	V2.00 e superiore

This test report is test results from the EUT only, not the product's quality certificate. It shall not be reproduced except in full without the written approval by PTEC.

Summary of verification report

Test result of report No. **PVTH200320N031** was result of Photovoltaic Grid-Tied Inverter model **HYD 10KTL-3PH**. It was verified by Electrical and Electronic Products Testing Center (PTEC) and **compiled** according to Requirements on Grid Connection of Provincial Electricity Authority BE 2559 (2016) as following.

No.	Item	Reference Report No.	Standard Reference	Verdict
1	Active power control	PVTH200320N031	PEA	Pass
2	Reactive power control	-	-	--
2.1	A Fixed Displacement Factor $\cos \theta$	PVTH200320N031	PEA	Pass
2.2	A variable reactive power depending on the voltage Q(U)	PVTH200320N031	PEA	Pass
3	Under/over frequency protection	PVTH200320N031	IEC 61727	Pass
4	Voltage fluctuation	PVTH200320N031	IEC 61000-3-11	Pass
5	Harmonics	PVTH200320N031	IEEE 1547.1	Pass
6	DC injection	PVTH200320N031	IEC 61727	Pass
7	Low voltage fault ride through	PVTH200320N031	PEA	Pass
8	Under/over voltage protection	PVTH200320N031	IEC 61727	Pass
9	Anti-islanding	PVTH200320N031	IEC 62116	Pass
10	Response to utility recovery	PVTH200320N031	IEC 61727	Pass

This report consists of the following document:

1. Verification Result (10 Page)
2. Attach Document Reference Report No. PVTH200320N031 (63 Page)

Standard Reference;

- **IEEE 1547.1 2005** Interconnecting Distributed Resources with Electric Power Systems
- **IEC 62116:2008**: Utility-interconnected photovoltaic inverters - Test procedure of islanding prevention measures
- **IEC 61727** Photovoltaic (PV) systems - Characteristics of the utility interface
- **IEC 61000-3-11**: Electromagnetic compatibility (EMC) - Part 3-11: Limits - Limitation of voltage fluctuations and flicker in low-voltage power supply systems for equipment with rated current > 75 A
- **PEA**: Thailand according to the grid-connected inverter regulations of the Provincial Electricity Authority (PEA):2016

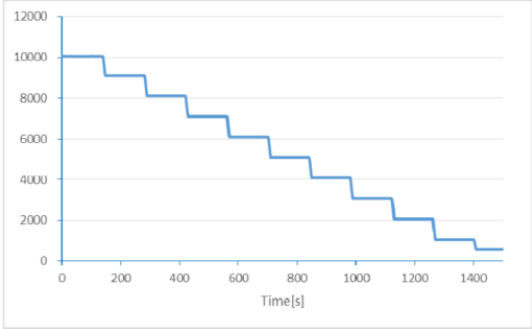
VERIFICATION REPORT			
Clause	PEA Requirement	Result – Remark	Verdict
8.1.2	<p>Active Power Control</p> <p>The power generating system of VSPP must be capable of reducing electric power from 100 %to zero by decreasing 10 % electric power per one minute .In this regard, if there is any abnormality occurred in the grid system or any incident considered by PEA as an impact affecting safety and stability of the grid system, PEA would inform and/or give an order to the VSPP to reduce electric power as appropriate.</p>	<p>Active Power Control</p> <p>1) Requirement The requirements on Grid Connection of Provincial Electricity Authority</p> <p>2) Test result See Test report no: PVTH200320N031, Page 43</p> <p>3) Verification test result</p> <p>The PV inverter is capable of reducing electric power from 100 %to zero by decreasing 10 % electric power per one minute.</p>  <p>-Maximum active power deviation to set point 6.0%</p>	Pass
8.1.3	<p>Reactive Power Control</p> <p>The power generating system of VSPP must be able to control power factor)PF (or reactive power to maintain voltage level at PCC aligned with PEA’s standards .The power generating system of service applicants must have capacity as stated in Table 1.</p>	<p>Reactive Power Control</p> <p>1) Requirement The requirements on Grid Connection of Provincial Electricity Authority</p> <p>2) Test result See Test report no : PVTH200320N031, <ul style="list-style-type: none"> - Page 36 Reactive power capability - Page 37- 38 A Fixed Displacement Factor cos θ test result - Page 39- 40 A variable reactive power depending on the voltage Q(U) test result. </p>	Pass

This test report is test results from the EUT only, not the product’s quality certificate. It shall not be reproduced except in full without the written approval by PTEC.

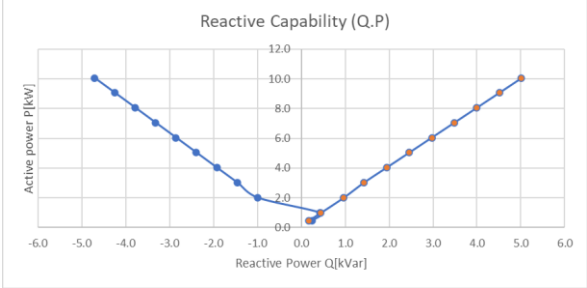
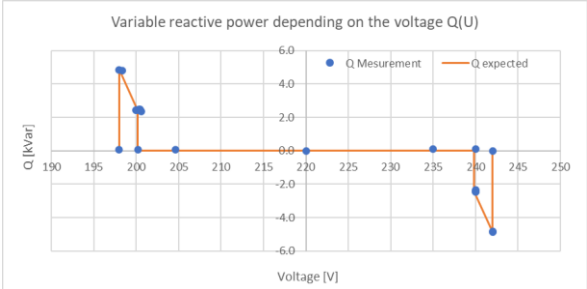
VERIFICATION REPORT																	
Clause	PEA Requirement	Result – Remark	Verdict														
		<p>3) Verification test result 3.1 Reactive power capability</p> 	Pass														
		<p>3.2 A Fixed Displacement Factor cos θ (PF 0.90) test</p> <table border="1" data-bbox="804 954 1361 1120"> <thead> <tr> <th rowspan="2">PF. Set point</th> <th colspan="2">PF. Measurement*</th> </tr> <tr> <th>Max</th> <th>Min</th> </tr> </thead> <tbody> <tr> <td>1.0</td> <td>1.000</td> <td>0.994</td> </tr> <tr> <td>0.90 lagging</td> <td>0.905</td> <td>0.887</td> </tr> <tr> <td>0.90 Leading</td> <td>0.909</td> <td>0.895</td> </tr> </tbody> </table> <p>*@Pout =10% to 100%</p>	PF. Set point	PF. Measurement*		Max	Min	1.0	1.000	0.994	0.90 lagging	0.905	0.887	0.90 Leading	0.909	0.895	Pass
PF. Set point	PF. Measurement*																
	Max	Min															
1.0	1.000	0.994															
0.90 lagging	0.905	0.887															
0.90 Leading	0.909	0.895															
		<p>A variable reactive power depending on the voltage Q(U) test result</p> 	Pass														

This test report is test results from the EUT only, not the product's quality certificate. It shall not be reproduced except in full without the written approval by PTEC.

VERIFICATION REPORT															
Clause	PEA Requirement	Result – Remark	Verdict												
8.2	<p>Under and Over Frequency Protection The power generating system of VSPP must disconnect itself from the grid system within 0.1 seconds if the frequency at PCC is not in the range of 47 Hz-52 Hz.</p>	<p>Under and Over Frequency Protection 1) Reference Standard IEC 61727 2) Test result See Test report no: PVTH200320N031 Page 27-28 3) Verification test result</p> <table border="1"> <thead> <tr> <th>Frequency at PCC</th> <th>Measured (Sec)</th> <th>Limit (Sec)</th> <th>Result</th> </tr> </thead> <tbody> <tr> <td>f < 47</td> <td>0.092</td> <td><0.1</td> <td>Pass</td> </tr> <tr> <td>f > 52</td> <td>0.092</td> <td><0.1</td> <td>Pass</td> </tr> </tbody> </table>	Frequency at PCC	Measured (Sec)	Limit (Sec)	Result	f < 47	0.092	<0.1	Pass	f > 52	0.092	<0.1	Pass	Pass
Frequency at PCC	Measured (Sec)	Limit (Sec)	Result												
f < 47	0.092	<0.1	Pass												
f > 52	0.092	<0.1	Pass												
8.3	<p>Voltage Fluctuation The power generating system of VSPP must not create voltage fluctuation exceeding the limit based on the PEA's rules concerning the Regulations on Grid Connection B.E.2559. Regulations on Grid Connection B.E.2559. The operation of the inverter should not cause voltage flicker in excess of limits : Short-term Severity Values (Pst) not exceed 1.0 Long-term Severity Values (Plt) not exceed 0.8</p>	<p>Voltage Fluctuation 1) Reference Standard IEC 61000-3-5 2) Test result See Test report no : PVTH200320N031, Page 12 3) Verification test result</p> <table border="1"> <thead> <tr> <th>Test item</th> <th>Limit</th> <th>Result</th> <th>Verdict</th> </tr> </thead> <tbody> <tr> <td>Pst</td> <td>1.0</td> <td>0.35</td> <td>Pass</td> </tr> <tr> <td>Plt</td> <td>0.8</td> <td>0.35</td> <td>Pass</td> </tr> </tbody> </table>	Test item	Limit	Result	Verdict	Pst	1.0	0.35	Pass	Plt	0.8	0.35	Pass	Pass
Test item	Limit	Result	Verdict												
Pst	1.0	0.35	Pass												
Plt	0.8	0.35	Pass												

This test report is test results from the EUT only, not the product's quality certificate. It shall not be reproduced except in full without the written approval by PTEC.

VERIFICATION REPORT																																																																																																																																																																												
Clause	PEA Requirement	Result – Remark	Verdict																																																																																																																																																																									
8.4	<p>Harmonic</p> <p>The power generating system of VSPP must not inject harmonic current to the grid system exceeding the limit based on the PEA's rules concerning the Regulations of Grid Connection B.E.2559.</p> <p>Regulations of Grid Connection B.E.2559.</p> <p>The Inverter output should have low current-distortion and low voltage distortion levels to ensure that no adverse effects are caused to other equipment connected to the utility system .Each individual harmonic shall be limited to the listed in Table 5.1 and Table 5-2 of attach 4.</p> <p style="text-align: center;">ตารางที่ 5-1 ขีดจำกัดกระแสฮาร์มอนิกสำหรับผู้ใช้ไฟฟ้าระบบที่จุดต่อร่วม *</p> <table border="1"> <thead> <tr> <th>ระดับแรงดันไฟฟ้าที่จุดต่อร่วม (kV)</th> <th colspan="18">อันดับฮาร์มอนิกและขีดจำกัดของกระแส (A rms)</th> </tr> <tr> <th></th> <th>2</th><th>3</th><th>4</th><th>5</th><th>6</th><th>7</th><th>8</th><th>9</th><th>10</th><th>11</th><th>12</th><th>13</th><th>14</th><th>15</th><th>16</th><th>17</th><th>18</th><th>19</th> </tr> </thead> <tbody> <tr> <td>0.400</td> <td>48</td><td>34</td><td>22</td><td>56</td><td>11</td><td>40</td><td>9</td><td>8</td><td>7</td><td>19</td><td>6</td><td>16</td><td>5</td><td>5</td><td>5</td><td>6</td><td>4</td><td>6</td> </tr> <tr> <td>11 and 12</td> <td>13</td><td>8</td><td>6</td><td>10</td><td>4</td><td>8</td><td>3</td><td>3</td><td>3</td><td>7</td><td>2</td><td>6</td><td>2</td><td>2</td><td>2</td><td>2</td><td>1</td><td>1</td> </tr> <tr> <td>22, 24 and 33</td> <td>11</td><td>7</td><td>5</td><td>9</td><td>4</td><td>6</td><td>3</td><td>2</td><td>2</td><td>6</td><td>2</td><td>5</td><td>2</td><td>1</td><td>1</td><td>2</td><td>1</td><td>1</td> </tr> <tr> <td>69</td> <td>8.8</td><td>5.9</td><td>4.3</td><td>7.3</td><td>3.3</td><td>4.9</td><td>2.3</td><td>1.6</td><td>1.6</td><td>4.9</td><td>1.6</td><td>4.3</td><td>1.6</td><td>1</td><td>1</td><td>1.6</td><td>1</td><td>1</td> </tr> <tr> <td>115 and above</td> <td>5</td><td>4</td><td>3</td><td>4</td><td>2</td><td>3</td><td>1</td><td>1</td><td>1</td><td>3</td><td>1</td><td>3</td><td>1</td><td>1</td><td>1</td><td>1</td><td>1</td><td>1</td> </tr> </tbody> </table> <p style="text-align: center;">ตารางที่ 5-2 ขีดจำกัดความถี่ฮาร์มอนิกของแรงดันสำหรับผู้ใช้ไฟฟ้าระบบที่จุดต่อร่วม (รวมทั้งระดับความถี่ที่มีอยู่เดิม)</p> <table border="1"> <thead> <tr> <th rowspan="2">ระดับแรงดันไฟฟ้าที่จุดต่อร่วม (kV)</th> <th rowspan="2">ค่าความถี่ฮาร์มอนิกรวมของแรงดัน (%)</th> <th colspan="2">ค่าความถี่ฮาร์มอนิกของแรงดันแต่ละอันดับ (%)</th> </tr> <tr> <th>อันดับที่</th> <th>อันดับที่</th> </tr> </thead> <tbody> <tr> <td>0.400</td> <td>5</td> <td>4</td> <td>2</td> </tr> <tr> <td>11, 12, 22 and 24</td> <td>4</td> <td>3</td> <td>1.75</td> </tr> <tr> <td>33</td> <td>3</td> <td>2</td> <td>1</td> </tr> <tr> <td>69</td> <td>2.45</td> <td>1.63</td> <td>0.82</td> </tr> <tr> <td>115 and above</td> <td>1.5</td> <td>1</td> <td>0.5</td> </tr> </tbody> </table>	ระดับแรงดันไฟฟ้าที่จุดต่อร่วม (kV)	อันดับฮาร์มอนิกและขีดจำกัดของกระแส (A rms)																			2	3	4	5	6	7	8	9	10	11	12	13	14	15	16	17	18	19	0.400	48	34	22	56	11	40	9	8	7	19	6	16	5	5	5	6	4	6	11 and 12	13	8	6	10	4	8	3	3	3	7	2	6	2	2	2	2	1	1	22, 24 and 33	11	7	5	9	4	6	3	2	2	6	2	5	2	1	1	2	1	1	69	8.8	5.9	4.3	7.3	3.3	4.9	2.3	1.6	1.6	4.9	1.6	4.3	1.6	1	1	1.6	1	1	115 and above	5	4	3	4	2	3	1	1	1	3	1	3	1	1	1	1	1	1	ระดับแรงดันไฟฟ้าที่จุดต่อร่วม (kV)	ค่าความถี่ฮาร์มอนิกรวมของแรงดัน (%)	ค่าความถี่ฮาร์มอนิกของแรงดันแต่ละอันดับ (%)		อันดับที่	อันดับที่	0.400	5	4	2	11, 12, 22 and 24	4	3	1.75	33	3	2	1	69	2.45	1.63	0.82	115 and above	1.5	1	0.5	<p>Harmonics</p> <p>1) Reference Standard IEEE1547.1-2005 Total harmonic current distortion is less than 5 %at rated inverter output Individual harmonics don't exceed the given distortion limit</p> <p>2) Test result See Test report no : PVTH200320N031, Page 15 to 19</p> <p>3) Verification test result</p> <table border="1"> <thead> <tr> <th>Item</th> <th>Verdict</th> </tr> </thead> <tbody> <tr> <td>THDi in each harmonic not exceed in table 5-1</td> <td>Pass</td> </tr> <tr> <td>Total harmonic current distortion less than 5 %</td> <td>Pass</td> </tr> <tr> <td>THDv in each harmonic not exceed in table 5-2</td> <td>Pass</td> </tr> <tr> <td>Total harmonic voltage distortion less than 5 %</td> <td>Pass</td> </tr> </tbody> </table>	Item	Verdict	THDi in each harmonic not exceed in table 5-1	Pass	Total harmonic current distortion less than 5 %	Pass	THDv in each harmonic not exceed in table 5-2	Pass	Total harmonic voltage distortion less than 5 %	Pass	Pass
ระดับแรงดันไฟฟ้าที่จุดต่อร่วม (kV)	อันดับฮาร์มอนิกและขีดจำกัดของกระแส (A rms)																																																																																																																																																																											
	2	3	4	5	6	7	8	9	10	11	12	13	14	15	16	17	18	19																																																																																																																																																										
0.400	48	34	22	56	11	40	9	8	7	19	6	16	5	5	5	6	4	6																																																																																																																																																										
11 and 12	13	8	6	10	4	8	3	3	3	7	2	6	2	2	2	2	1	1																																																																																																																																																										
22, 24 and 33	11	7	5	9	4	6	3	2	2	6	2	5	2	1	1	2	1	1																																																																																																																																																										
69	8.8	5.9	4.3	7.3	3.3	4.9	2.3	1.6	1.6	4.9	1.6	4.3	1.6	1	1	1.6	1	1																																																																																																																																																										
115 and above	5	4	3	4	2	3	1	1	1	3	1	3	1	1	1	1	1	1																																																																																																																																																										
ระดับแรงดันไฟฟ้าที่จุดต่อร่วม (kV)	ค่าความถี่ฮาร์มอนิกรวมของแรงดัน (%)	ค่าความถี่ฮาร์มอนิกของแรงดันแต่ละอันดับ (%)																																																																																																																																																																										
		อันดับที่	อันดับที่																																																																																																																																																																									
0.400	5	4	2																																																																																																																																																																									
11, 12, 22 and 24	4	3	1.75																																																																																																																																																																									
33	3	2	1																																																																																																																																																																									
69	2.45	1.63	0.82																																																																																																																																																																									
115 and above	1.5	1	0.5																																																																																																																																																																									
Item	Verdict																																																																																																																																																																											
THDi in each harmonic not exceed in table 5-1	Pass																																																																																																																																																																											
Total harmonic current distortion less than 5 %	Pass																																																																																																																																																																											
THDv in each harmonic not exceed in table 5-2	Pass																																																																																																																																																																											
Total harmonic voltage distortion less than 5 %	Pass																																																																																																																																																																											
8.5	<p>DC Injection</p> <p>The power generating system of VSPP must not supply direct current to the grid system exceeding the limit based on the PEA's regulations concerning the Regulations on Grid Connection B.E.2559.</p> <p>Regulations on Grid Connection B.E.2559.</p> <p>The inverter shall not inject DC current greater than 0.5 % of the rated inverter output current, into the utility AC interface under any operating condition.</p>	<p>DC Injection</p> <p>1) Reference Standard IEC 61727</p> <p>2) Test result See Test report no: PVTH200320N031, Page 14</p> <p>3) Verification test result</p> <table border="1"> <thead> <tr> <th>Output Power</th> <th>Limit [%]</th> <th>Max.DC [%]</th> <th>Verdict</th> </tr> </thead> <tbody> <tr> <td>33%</td> <td>0.5</td> <td>0.06</td> <td>Pass</td> </tr> <tr> <td>66%</td> <td>0.5</td> <td>0.21</td> <td>Pass</td> </tr> <tr> <td>100%</td> <td>0.5</td> <td>0.14</td> <td>Pass</td> </tr> </tbody> </table>	Output Power	Limit [%]	Max.DC [%]	Verdict	33%	0.5	0.06	Pass	66%	0.5	0.21	Pass	100%	0.5	0.14	Pass	Pass																																																																																																																																																									
Output Power	Limit [%]	Max.DC [%]	Verdict																																																																																																																																																																									
33%	0.5	0.06	Pass																																																																																																																																																																									
66%	0.5	0.21	Pass																																																																																																																																																																									
100%	0.5	0.14	Pass																																																																																																																																																																									

This test report is test results from the EUT only, not the product's quality certificate. It shall not be reproduced except in full without the written approval by PTEC.

VERIFICATION REPORT																																																																																																			
Clause	PEA Requirement	Result – Remark			Verdict																																																																																														
12.1	<p>Low Voltage Fault Ride Through</p> <p>The power system of VSPP must not disconnect itself from the grid system within the required period during temporary low voltage of the grid system .The voltage at PCC is determined as shown in Table Fault Ride Through</p> <p>Duration of Low Voltage Fault Ride Through</p> <table border="1"> <thead> <tr> <th>Voltage at PCC</th> <th>Duration Time (Second)</th> </tr> </thead> <tbody> <tr> <td>1) Low voltage 2) Moderate voltage or high voltage (electrical installation not exceeding 500 kilowatt).</td> <td>Not required.</td> </tr> <tr> <td>3) Moderate voltage or high voltage (electrical installation exceeding 500 kilowatt).</td> <td>As shown in Picture 1.</td> </tr> </tbody> </table> <p>Picture 1. Low Voltage Fault Ride Through</p>	Voltage at PCC	Duration Time (Second)	1) Low voltage 2) Moderate voltage or high voltage (electrical installation not exceeding 500 kilowatt).	Not required.	3) Moderate voltage or high voltage (electrical installation exceeding 500 kilowatt).	As shown in Picture 1.	<p>Low Voltage Fault Ride Through</p> <p>1) Requirement</p> <p>The requirements on Grid Connection of Provincial Electricity Authority</p> <p>2) Test result</p> <p>See Test report no: PVTH200320N031, Page 44-54</p> <p>3) Verification test result</p> <p>3.1) Output Power >0.9Pn</p> <table border="1"> <thead> <tr> <th>Test List</th> <th>V (V/Vn)</th> <th>Duration (mS)</th> <th>Limit (mS)</th> <th>verdict</th> </tr> </thead> <tbody> <tr> <td rowspan="3">Three-phase faults</td> <td>0.7-0.8 Vn</td> <td>1019</td> <td>>993.75</td> <td>P</td> </tr> <tr> <td>0.3-0.5 Vn</td> <td>161</td> <td>>150</td> <td>P</td> </tr> <tr> <td>0-0.049Vn</td> <td>161</td> <td>>150</td> <td>P</td> </tr> <tr> <td rowspan="3">Phase to phase faults</td> <td>0.7-0.8 Vn</td> <td>1014</td> <td>>993.75</td> <td>P</td> </tr> <tr> <td>0.3-0.5 Vn</td> <td>160</td> <td>>150</td> <td>P</td> </tr> <tr> <td>0-0.049Vn</td> <td>161</td> <td>>150</td> <td>P</td> </tr> <tr> <td rowspan="3">Phase to ground faults</td> <td>0.7-0.8 Vn</td> <td>1017</td> <td>>993.75</td> <td>P</td> </tr> <tr> <td>0.3-0.5 Vn</td> <td>160</td> <td>>150</td> <td>P</td> </tr> <tr> <td>0-0.049Vn</td> <td>161</td> <td>>150</td> <td>P</td> </tr> </tbody> </table> <p>3.2) Output Power 0.3Pn</p> <table border="1"> <thead> <tr> <th>Test List</th> <th>V (V/Vn)</th> <th>Duration (mS)</th> <th>Limit (mS)</th> <th>verdict</th> </tr> </thead> <tbody> <tr> <td rowspan="3">Three-phase faults</td> <td>0.7-0.8 Vn</td> <td>1016</td> <td>>993.75</td> <td>P</td> </tr> <tr> <td>0.3-0.5 Vn</td> <td>161</td> <td>>150</td> <td>P</td> </tr> <tr> <td>0-0.049Vn</td> <td>161</td> <td>>150</td> <td>P</td> </tr> <tr> <td rowspan="3">Phase to phase faults</td> <td>0.7-0.8 Vn</td> <td>1014</td> <td>>993.75</td> <td>P</td> </tr> <tr> <td>0.3-0.5 Vn</td> <td>161</td> <td>>150</td> <td>P</td> </tr> <tr> <td>0-0.049Vn</td> <td>161</td> <td>>150</td> <td>P</td> </tr> <tr> <td rowspan="3">Phase to ground faults</td> <td>0.7-0.8 Vn</td> <td>1017</td> <td>>993.75</td> <td>P</td> </tr> <tr> <td>0.3-0.5 Vn</td> <td>161</td> <td>>150</td> <td>P</td> </tr> <tr> <td>0-0.049Vn</td> <td>160</td> <td>>150</td> <td>P</td> </tr> </tbody> </table>			Test List	V (V/Vn)	Duration (mS)	Limit (mS)	verdict	Three-phase faults	0.7-0.8 Vn	1019	>993.75	P	0.3-0.5 Vn	161	>150	P	0-0.049Vn	161	>150	P	Phase to phase faults	0.7-0.8 Vn	1014	>993.75	P	0.3-0.5 Vn	160	>150	P	0-0.049Vn	161	>150	P	Phase to ground faults	0.7-0.8 Vn	1017	>993.75	P	0.3-0.5 Vn	160	>150	P	0-0.049Vn	161	>150	P	Test List	V (V/Vn)	Duration (mS)	Limit (mS)	verdict	Three-phase faults	0.7-0.8 Vn	1016	>993.75	P	0.3-0.5 Vn	161	>150	P	0-0.049Vn	161	>150	P	Phase to phase faults	0.7-0.8 Vn	1014	>993.75	P	0.3-0.5 Vn	161	>150	P	0-0.049Vn	161	>150	P	Phase to ground faults	0.7-0.8 Vn	1017	>993.75	P	0.3-0.5 Vn	161	>150	P	0-0.049Vn	160	>150	P	Pass
Voltage at PCC	Duration Time (Second)																																																																																																		
1) Low voltage 2) Moderate voltage or high voltage (electrical installation not exceeding 500 kilowatt).	Not required.																																																																																																		
3) Moderate voltage or high voltage (electrical installation exceeding 500 kilowatt).	As shown in Picture 1.																																																																																																		
Test List	V (V/Vn)	Duration (mS)	Limit (mS)	verdict																																																																																															
Three-phase faults	0.7-0.8 Vn	1019	>993.75	P																																																																																															
	0.3-0.5 Vn	161	>150	P																																																																																															
	0-0.049Vn	161	>150	P																																																																																															
Phase to phase faults	0.7-0.8 Vn	1014	>993.75	P																																																																																															
	0.3-0.5 Vn	160	>150	P																																																																																															
	0-0.049Vn	161	>150	P																																																																																															
Phase to ground faults	0.7-0.8 Vn	1017	>993.75	P																																																																																															
	0.3-0.5 Vn	160	>150	P																																																																																															
	0-0.049Vn	161	>150	P																																																																																															
Test List	V (V/Vn)	Duration (mS)	Limit (mS)	verdict																																																																																															
Three-phase faults	0.7-0.8 Vn	1016	>993.75	P																																																																																															
	0.3-0.5 Vn	161	>150	P																																																																																															
	0-0.049Vn	161	>150	P																																																																																															
Phase to phase faults	0.7-0.8 Vn	1014	>993.75	P																																																																																															
	0.3-0.5 Vn	161	>150	P																																																																																															
	0-0.049Vn	161	>150	P																																																																																															
Phase to ground faults	0.7-0.8 Vn	1017	>993.75	P																																																																																															
	0.3-0.5 Vn	161	>150	P																																																																																															
	0-0.049Vn	160	>150	P																																																																																															

This test report is test results from the EUT only, not the product's quality certificate. It shall not be reproduced except in full without the written approval by PTEC.

VERIFICATION REPORT																																																	
Clause	PEA Requirement	Result – Remark			Verdict																																												
		3.3) Output Power 0.1Pn <table border="1"> <thead> <tr> <th>Test List</th> <th>V (V/Vn)</th> <th>Duration (mS)</th> <th>Limit (mS)</th> <th>verdict</th> </tr> </thead> <tbody> <tr> <td rowspan="3">Three-phase faults</td> <td>0.7-0.8 Vn</td> <td>1013</td> <td>>993.75</td> <td>P</td> </tr> <tr> <td>0.3-0.5 Vn</td> <td>161</td> <td>>150</td> <td>P</td> </tr> <tr> <td>0-0.049Vn</td> <td>161</td> <td>>150</td> <td>P</td> </tr> <tr> <td rowspan="3">Phase to Phase faults</td> <td>0.7-0.8 Vn</td> <td>1019</td> <td>>993.75</td> <td>P</td> </tr> <tr> <td>0.3-0.5 Vn</td> <td>161</td> <td>>150</td> <td>P</td> </tr> <tr> <td>0-0.049Vn</td> <td>161</td> <td>>150</td> <td>P</td> </tr> <tr> <td rowspan="3">Phase to ground faults</td> <td>0.7-0.8 Vn</td> <td>1016</td> <td>>993.75</td> <td>P</td> </tr> <tr> <td>0.3-0.5 Vn</td> <td>161</td> <td>>150</td> <td>P</td> </tr> <tr> <td>0-0.049Vn</td> <td>161</td> <td>>150</td> <td>P</td> </tr> </tbody> </table>			Test List	V (V/Vn)	Duration (mS)	Limit (mS)	verdict	Three-phase faults	0.7-0.8 Vn	1013	>993.75	P	0.3-0.5 Vn	161	>150	P	0-0.049Vn	161	>150	P	Phase to Phase faults	0.7-0.8 Vn	1019	>993.75	P	0.3-0.5 Vn	161	>150	P	0-0.049Vn	161	>150	P	Phase to ground faults	0.7-0.8 Vn	1016	>993.75	P	0.3-0.5 Vn	161	>150	P	0-0.049Vn	161	>150	P	Pass
Test List	V (V/Vn)	Duration (mS)	Limit (mS)	verdict																																													
Three-phase faults	0.7-0.8 Vn	1013	>993.75	P																																													
	0.3-0.5 Vn	161	>150	P																																													
	0-0.049Vn	161	>150	P																																													
Phase to Phase faults	0.7-0.8 Vn	1019	>993.75	P																																													
	0.3-0.5 Vn	161	>150	P																																													
	0-0.049Vn	161	>150	P																																													
Phase to ground faults	0.7-0.8 Vn	1016	>993.75	P																																													
	0.3-0.5 Vn	161	>150	P																																													
	0-0.049Vn	161	>150	P																																													
12.2	<p>Under and Over Voltage Protection</p> <p>The power system of VSPP must disconnect itself from the grid system if voltage level of line to neutral in the utility system is out of ranges as stated in Table 3.</p> <p>Table 3. The Disconnect Duration of Falling Voltage Out of Rated Voltage Ranges</p> <table border="1"> <thead> <tr> <th>Voltage at PCC</th> <th>Disconnect Duration (Second)</th> </tr> </thead> <tbody> <tr> <td>V < 50%</td> <td>0.3</td> </tr> <tr> <td>50% ≤ V < 90%</td> <td>2.0</td> </tr> <tr> <td>90% ≤ V ≤ 110%</td> <td>continual voltage</td> </tr> <tr> <td>110% < V < 120%</td> <td>1.0</td> </tr> <tr> <td>V ≥ 120%</td> <td>0.16</td> </tr> </tbody> </table>	Voltage at PCC	Disconnect Duration (Second)	V < 50%	0.3	50% ≤ V < 90%	2.0	90% ≤ V ≤ 110%	continual voltage	110% < V < 120%	1.0	V ≥ 120%	0.16	<p>Under and Over Voltage Protection</p> <p>1) Reference Standard IEC 61727</p> <p>2) Test result See Test report no: PVTH200320N031 Page 21-24</p> <p>3) Verification test result</p> <table border="1"> <thead> <tr> <th>Voltage at PCC</th> <th>Max Meas. (Sec)</th> <th>Limit (Sec)</th> <th>Result</th> </tr> </thead> <tbody> <tr> <td>V < 50%</td> <td>0.210</td> <td><0.3</td> <td>Pass</td> </tr> <tr> <td>50% ≤ V < 90%</td> <td>1.680</td> <td><2.0</td> <td>Pass</td> </tr> <tr> <td>90% ≤ V ≤ 110%</td> <td>No trip</td> <td>Cont.</td> <td>Pass</td> </tr> <tr> <td>110% < V < 120%</td> <td>0.640</td> <td><1.0</td> <td>Pass</td> </tr> <tr> <td>V ≥ 120%</td> <td>0.082</td> <td><0.16</td> <td>Pass</td> </tr> </tbody> </table>			Voltage at PCC	Max Meas. (Sec)	Limit (Sec)	Result	V < 50%	0.210	<0.3	Pass	50% ≤ V < 90%	1.680	<2.0	Pass	90% ≤ V ≤ 110%	No trip	Cont.	Pass	110% < V < 120%	0.640	<1.0	Pass	V ≥ 120%	0.082	<0.16	Pass	Pass								
Voltage at PCC	Disconnect Duration (Second)																																																
V < 50%	0.3																																																
50% ≤ V < 90%	2.0																																																
90% ≤ V ≤ 110%	continual voltage																																																
110% < V < 120%	1.0																																																
V ≥ 120%	0.16																																																
Voltage at PCC	Max Meas. (Sec)	Limit (Sec)	Result																																														
V < 50%	0.210	<0.3	Pass																																														
50% ≤ V < 90%	1.680	<2.0	Pass																																														
90% ≤ V ≤ 110%	No trip	Cont.	Pass																																														
110% < V < 120%	0.640	<1.0	Pass																																														
V ≥ 120%	0.082	<0.16	Pass																																														

This test report is test results from the EUT only, not the product's quality certificate. It shall not be reproduced except in full without the written approval by PTEC.

VERIFICATION REPORT																			
Clause	PEA Requirement	Result – Remark	Verdict																
12.3	<p>Anti-Islanding In order to prevent anti-islanding while there is no electricity in grid system to be supplied to the power system of VSPP, the power generating system of VSPP must disconnect itself from the utility system within 1 seconds.</p>	<p>Anti-Islanding 1) Reference Standard IEC 62116 2) Test result See Test report no: PVTH200320N031 Page 29-35 3) Verification test result</p> <table border="1"> <thead> <tr> <th>% Off P_{outrating}</th> <th>Maximum Runtime (Sec)</th> <th>Limit (Sec)</th> <th>Result</th> </tr> </thead> <tbody> <tr> <td>100</td> <td>0.524</td> <td>< 1.0</td> <td>Pass</td> </tr> <tr> <td>66</td> <td>0.530</td> <td>< 1.0</td> <td>Pass</td> </tr> <tr> <td>33</td> <td>0.536</td> <td>< 1.0</td> <td>Pass</td> </tr> </tbody> </table>	% Off P _{outrating}	Maximum Runtime (Sec)	Limit (Sec)	Result	100	0.524	< 1.0	Pass	66	0.530	< 1.0	Pass	33	0.536	< 1.0	Pass	Pass
% Off P _{outrating}	Maximum Runtime (Sec)	Limit (Sec)	Result																
100	0.524	< 1.0	Pass																
66	0.530	< 1.0	Pass																
33	0.536	< 1.0	Pass																
12.4	<p>Response to Utility Recovery After the power generating system of VSPP disconnect itself from the grid system because of power outage or voltage/frequency is out of the ranges, when the grid system is back to normal, the power system of VSPP must delay the time to reconnect itself to the grid system at a minimum of 20 seconds to 5 minutes.</p>	<p>Response to Utility Recovery 1) Reference Standard IEC 61727 2) Test result See Test report no: PVTH200320N031 Page 21-22, 25-27 3) Verification test result</p> <table border="1"> <thead> <tr> <th>Limit Recovery time (Sec)</th> <th>Max. Measurement Recovery time (Sec)</th> <th>Result</th> </tr> </thead> <tbody> <tr> <td>20 - 300</td> <td>63</td> <td>Pass</td> </tr> </tbody> </table>	Limit Recovery time (Sec)	Max. Measurement Recovery time (Sec)	Result	20 - 300	63	Pass	Pass										
Limit Recovery time (Sec)	Max. Measurement Recovery time (Sec)	Result																	
20 - 300	63	Pass																	

----- END OF REPORT -----

This test report is test results from the EUT only, not the product's quality certificate. It shall not be reproduced except in full without the written approval by PTEC.



TEST REPORT

IEC 61727 / IEC 62116



Photovoltaic (PV) systems Characteristics of the utility interface Test procedure of islanding prevention measures for utility-interconnected photovoltaic inverters

Report reference number	PVTH200320N031
Date of issue	2020-07-07
Total number of pages	63
Testing laboratory name	Bureau Veritas Shenzhen Co., Ltd. Dongguan Branch
Address	No. 96, Guantai Road (Houjie Section), Houjie Town, Dongguan City, Guangdong Province, 523942, People's Republic of China
Accreditation	  Certificate # 2951.01
Applicant's name.....	Shenzhen SOFAR SOLAR Co., Ltd.
Address	401, Building 4, AnTongDa Industrial Park, District 68, XingDong Community, XinAn Street, BaoAn District, Shenzhen, China
Test specification	
Standard.....	IEC 61727:2004, IEC 62116:2008, Deviations for Thailand according the grid-connected inverter regulations of the Provincial Electricity Authority (PEA:2016)
Test Report Form No.	IEC61727/IEC62116_PEA VER.2
TRF Originator	Bureau Veritas Shenzhen Co., Ltd. Dongguan Branch
Master TRF	Dated 2020-03-20
Test item description	Hybrid inverter
Trademark.....	
Model / Type	HYD 10KTL-3PH
<small>This report is governed by, and incorporates by reference, CPS Conditions of Service as posted at the date of issuance of this report at http://www.bureauveritas.com/home/about-us/our-business/cps/about-us/terms-conditions and is intended for your exclusive use. Any copying or replication of this report to or for any other person or entity, or use of our name or trademark, is permitted only with our prior written permission. This report sets forth our findings solely with respect to the test samples identified herein. The results set forth in this report are not indicative or representative of the quality or characteristics of the lot from which a test sample was taken or any similar or identical product unless specifically and expressly noted. Our report includes all of the tests requested by you and the results thereof based upon the information that you provided to us. Measurement uncertainty is only provided upon request for accredited tests. You have 60 days from date of issuance of this report to notify us of any material error or omission caused by our negligence or if you require measurement uncertainty; provided, however, that such notice shall be in writing and shall specifically address the issue you wish to raise. A failure to raise such issue within the prescribed time shall constitute your unqualified acceptance of the completeness of this report, the tests conducted and the correctness of the report contents.</small>	



Report No.: PVTH200320N031

Ratings	HYD 10KTL-3PH
Full power MPPT voltage range [V] . :	220-850V
MPP DC voltage range [V]	180-960V
Input DC current [A]	Max. 25.0 x 2
Isc PV [A].....	Max. 30.0 x 2
Output AC voltage [V]	3/N/PE, 380/400,50Hz
Max. Output AC current [A]	16
Rated Output power [VA]	10000
Max Output power [VA]	11000
Battery input voltage [V]	180-800
Battery current [A]	Max. 25A*2

Testing Location	Bureau Veritas Shenzhen Co., Ltd. Dongguan Branch	
Address	No. 96, Guantai Road (Houjie Section), Houjie Town, Dongguan City, Guangdong Province, 523942, People's Republic of China	
Tested by (name and signature)	Lukes Zhang	
Approved by (name and signature)	James Huang	
Manufacturer's name	Shenzhen SOFAR SOLAR Co., Ltd.	
Manufacturer's address	401, Building 4, AnTongDa Industrial Park, District 68, XingDong Community, XinAn Street, BaoAn District, Shenzhen, China.	
Factory's name	Dongguan SOFAR SOLAR Co.,Ltd.	
Factory address	1F - 6F, Building E, No. 1 JinQi Road, Bihu Industrial Park, Wulian Village, Fenggang Town, Dongguan City	

Document History			
Date	Internal reference	Modification / Change / Status	Revision
2020-07-07	Lukes Zhang	Initial report was written	0
Supplementary information:			

**Test items particulars**

Equipment mobility..... : Permanent connection
 Operating condition..... : Continuous
 Class of equipment..... : Class I
 Protection against ingress of water.. : IP65 according to EN 60529
 Mass of equipment [kg]..... : Approx. 37

Test case verdicts

Test case does not apply
 to the test object..... : N/A
 Test item does meet
 the requirement..... : P(ass)
 Test item does not meet
 the requirement..... : F(ail)

Testing

Date of receipt of test item..... : 2020-03-20
 Date(s) of performance of test..... : 2020-03-20 to 2020-07-07

General remarks:

The test result presented in this report relate only to the object(s) tested.
 This report must not be reproduced in part or in full without the written approval of the issuing testing laboratory.

"(see Annex #)" refers to additional information appended to the report.

"(see appended table)" refers to a table appended to the report.

Throughout this report a comma is used as the decimal separator.

This Test Report consists of the following documents:

1. Test Results
2. Annex No. 1 –Test equipment list
3. Annex No. 2 –Test equipment list

Copy of marking plate:

 SOFAR SOLAR Hybrid Inverter	
Model No:	HYD 10KTL-3PH
Max.DC Voltage	1000V
MPPT Voltage Range	180~960V
Max. Input Current	25/25A
Max.PV Isc	30/30A
Battery Type	Li-Ion
Battery Voltage Range	180~800V
Battery Max. Charging Current	25/25A
Battery Max. Discharging Current	25/25A
Nominal Grid/Back-up Voltage	3/N/PE, 380/400V
Nominal Grid/Back-up Frequency	50/60Hz
Max. Current Output to Grid	16A
Max. Power Output to Grid	11000VA
Max. Current from Grid	29A
Max. Power from Grid	20000VA
Back-up Max. Output Current	16A
Back-up Max. Output Power	11000VA
Power Factor	1(adjustable+/-0.8)
Operating Temperature Range	-30~+60°C
Ingress Protection	IP65
Protective Class	Class I
Inverter Topology	Non-isolated
Oversvoltage Category	AC III, DC II
Manufacturer : Shenzhen SOFAR SOLAR Co.,Ltd. Address : 401, Building 4, AnTongDa Industrial Park, District 68, XingDong Community,XinAn Street, BaoAn District, Shenzhen, China	
SAA VDE0126-1-1,VDE-AR-N4105 G98,G99,EN50438,AS4777,UTE C15-712-1	
	

General product information:

The Solar converter converts DC voltage into AC voltage.

The DC input of Solar converter can be supplied from PV array and Batteries.

The charging current to batteries from PV array or grid, battery management unit is integrated in External Energy storage.

The unit is providing EMC filtering at the output toward mains. The unit does not provide galvanic separation from input to output (transformerless). The output is switched off redundant by the high power switching bridge and a two relays. This assures that the opening of the output circuit will also operate in case of one error.

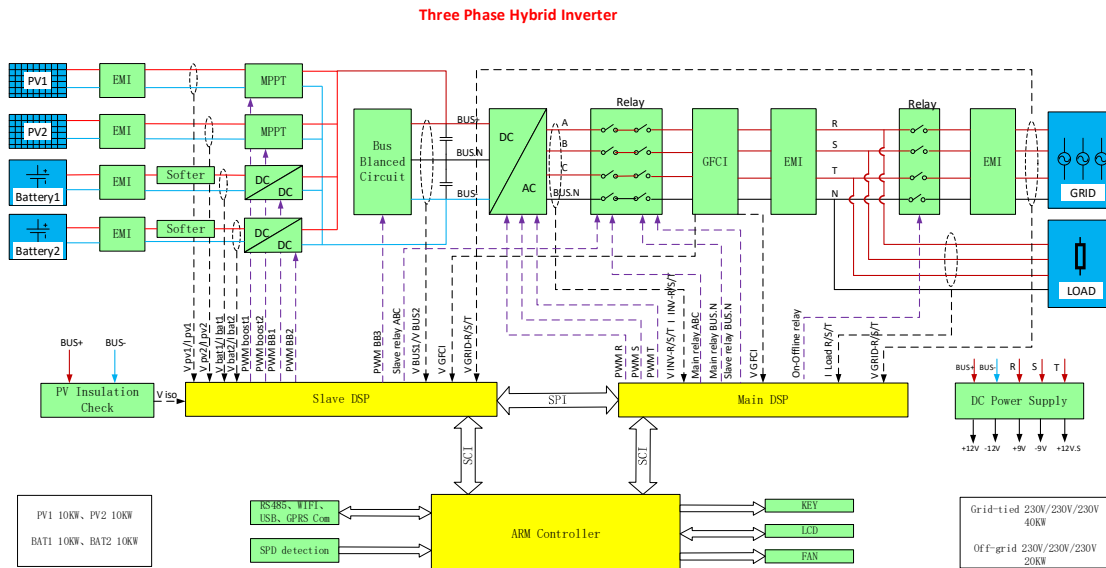

Figure 1-Block diagram

The internal control is redundant built. It consists of Main DSP (U37) and slave DSP (U39).

The Main MCU(U37) can control the relays, measures voltage, and frequency, AC current with injected DC, insulation resistance and residual current, In addition it tests the array insulation resistance and the RCMU circuit before each start up.

The slave MCU (U39) is using for controlling the relays, measuring the voltage , frequency, inject a dc AC current, the residual current, and communicating with the master MCU (U37). And if the communicating with the master DSP, the slave DSP will disconnect the relays.

The unit provides two relays in series on Line and Neutral conductors. When single-fault applied to one relay, alarm an error code in display panel, another redundant relay provides basic insulation maintained between the PV array and the mains. All the relays are tested before start up. Both controllers Main MCU(U39), Slave MCU (U37) can open the relays.

The product was tested on:

Hardware version: V1.0

Software version: V2.00 e superiore

**Interface protection settings with deviations according the grid-connected inverter regulations of the Provincial Electricity Authority (PEA:2016)
(Thailand PEA)**

Parameter	Max. clearance time*	Trip setting
Over voltage (level 2)	0,16s	220V +20% (264V)
Over voltage (level 1)	1,0s	220V +10% (242V)
Under voltage (level 1)	2,0s	220V -10% (198V)
Under voltage (level 2)	0,3s	220V -50% (110V)
Over frequency	0,1s	50Hz +4% (52,0Hz)
Under frequency	0,1s	50Hz -6% (47,0Hz)
Reconnection time	20s - 5min	
Permanent DC-injection	0,5% of rated inverter output current	
Loss of main IEC 62116:2008	Inverter shall detect and disconnect within 1s	

* Trip time refers to the time between the abnormal condition occurring and the inverter ceasing to energize the utility line. The PV system control circuits shall actually remain connected to the utility to allow sensing of utility electrical conditions for use by the "reconnect" feature.

IEC61727:2004			
Clause	Requirement – Test	Result – Remark	Verdict
SECTION 4: Utility compatibility			
4	<p>General The quality of power provided by the PV system for the on-site AC loads and for power delivered to the utility is governed by practices and standards on voltage, flicker, frequency, harmonics and power factor. Deviation from these standards represents out-of-bounds conditions and may require the PV system to sense the deviation and properly disconnect from the utility system.</p> <p>All power quality parameters (voltage, flicker, frequency, harmonics, and power factor) must be measured at the utility interface/ point of common coupling unless otherwise specified.</p>	Noticed	P
4.1	<p>Voltage, current and frequency The PV system AC voltage, current and frequency shall be compatible with the utility system.</p>	Derived from tests	P
4.2	<p>Normal voltage operating range Utility-interconnected PV systems do not normally regulate voltage; they inject current into the utility. Therefore, the voltage operating range for PV inverters is selected as a protection function that responds to abnormal utility conditions, not as a voltage regulation function.</p>	Derived from tests	P
4.3	<p>Flicker The operation of the PV system should not cause voltage flicker in excess of limits stated in the relevant sections of IEC 61000-3-3 for systems less than 16 A or IEC 61000-3-5 for systems with current of 16 A and above.</p>	See table 4.3	P
4.4	<p>DC injection The PV system shall not inject DC current greater than 1 % of the rated inverter output current, into the utility AC interface under any operating condition.</p>	<p>The following deviations were used: Provincial Electricity Authority (PEA:2016)</p> <p>See table 4.4</p>	P
4.5	<p>Normal frequency operating range The PV system shall operate in synchronism with the utility system, and within the frequency trip limits defined in 5.2.2.</p>	<p>The following deviations were used: Provincial Electricity Authority (PEA:2016)</p> <p>See table 5.2.2</p>	P



IEC61727:2004			
Clause	Requirement – Test	Result – Remark	Verdict
SECTION 4: Utility compatibility			
4.6	<p>Harmonics and waveform distortion</p> <p>Low levels of current and voltage harmonics are desirable; the higher harmonic levels increase the potential for adverse effects on connected equipment. Acceptable levels of harmonic voltage and current depend upon distribution system characteristics, type of service, connected loads/apparatus, and established utility practice.</p> <p>The PV system output should have low current-distortion levels to ensure that no adverse effects are caused to other equipment connected to the utility system.</p> <p>Total harmonic current distortion shall be less than 5 % at rated inverter output. Each individual harmonic shall be limited to the percentages listed in Table 1. Even harmonics in these ranges shall be less than 25 % of the lower odd harmonic limits listed. (see Clause 4.6 Table 1 – Current distortion limits)</p>	<p>The following deviations were used: Provincial Electricity Authority (PEA:2016)</p> <p>See tables 4.6 (1) and 4.6 (2)</p>	P
4.7	<p>Power factor</p> <p>The PV system shall have a lagging power factor greater than 0,9 when the output is greater than 50 % of the rated inverter output power.</p>	See table 3.4	P

IEC61727:2004			
Clause	Requirement – Test	Result – Remark	Verdict
SECTION 5: Personnel safety and equipment protection			
5	General This Clause provides information and considerations for the safe and proper operation of the utility-connected PV systems.	Noticed	P
5.1	Loss of utility voltage To prevent islanding, a utility connected PV system shall cease to energize the utility system from a de-energized distribution line irrespective of connected loads or other generators within specified time limits. A utility distribution line can become de-energized for several reasons. For example, a substation breaker opening due to fault conditions or the distribution line switched out during maintenance. If inverters (single or multiple) have DC SELV input and have accumulated power below 1 kW then no mechanical disconnect (relay) is required.	The following deviations were used: Provincial Electricity Authority (PEA:2016)	P
5.2	Over/under voltage and frequency Abnormal conditions can arise on the utility system that requires a response from the connected photovoltaic system. This response is to ensure the safety of utility maintenance personnel and the general public, as well as to avoid damage to connected equipment, including the photovoltaic system. The abnormal utility conditions of concern are voltage and frequency excursions above or below the values stated in this Clause, and the complete disconnection of the utility, presenting the potential for a distributed resource island.	The following deviations were used: Provincial Electricity Authority (PEA:2016) See table 5.2.1 and 5.2.2	P
5.2.1	Over/under voltage When the interface voltage deviates outside the conditions specified in Table 2, the photovoltaic system shall cease to energize the utility distribution system. This applies to any phase of a multiphase system. All discussions regarding system voltage refer to the local nominal voltage. The system shall sense abnormal voltage and respond. The following conditions should be met, with voltages in RMS and measured at the point of utility connection. (see clause 5.2.1 Table 2 – Response to abnormal voltages) The purpose of the allowed time delay is to ride through short-term disturbances to avoid excessive nuisance tripping. The unit does not have to cease to energize if the voltage returns to the normal utility continuous operation condition within the specified trip time.	The following deviations were used: Provincial Electricity Authority (PEA:2016) See table 5.2.1	P

IEC61727:2004			
Clause	Requirement – Test	Result – Remark	Verdict
SECTION 5: Personnel safety and equipment protection			
5.2.2	<p>Over/under frequency When the utility frequency deviates outside the specified conditions the photovoltaic system shall cease to energize the utility line. The unit does not have to cease to energize if the frequency returns to the normal utility continuous operation condition within the specified trip time.</p> <p>When the utility frequency is outside the range of ± 1 Hz, the system shall cease to energize the utility line within 0,2 s. The purpose of the allowed range and time delay is to allow continued operation for short-term disturbances and to avoid excessive nuisance tripping in weak-utility system conditions.</p>	<p>The following deviations were used: Provincial Electricity Authority (PEA:2016)</p> <p>See table 5.2.2</p>	P
5.3	<p>Islanding protection The PV system must cease to energize the utility line within 2 s of loss of utility.</p>	<p>The following deviations were used: Provincial Electricity Authority (PEA:2016)</p> <p>See table 6.1</p>	P
5.4	<p>Response to utility recovery Following an out-of-range utility condition that has caused the photovoltaic system to cease energizing, the photovoltaic system shall not energize the utility line for 20 s to 5 min after the utility service voltage and frequency have recovered to within the specified ranges.</p>	See table 5.2.1 and 5.2.2	P
5.5	<p>Earthing The utility interface equipment shall be earthed/grounded in accordance with IEC 60364-7-712.</p>	Stated in the manual.	P
5.6	<p>Short circuit protection The photovoltaic system shall have short-circuit protection in accordance with IEC 60364-7-712.</p>	Stated in the manual.	P
5.7	<p>Isolation and switching A method of isolation and switching shall be provided in accordance with IEC 60364-7-712.</p>	Stated in the manual.	P

Test overview:

IEC 61727:2004

Clause	Type Test	Result
4	Type test:	
4.3	Voltage Fluctuations and Flicker	P
4.4	Monitoring of DC-Injection	P
4.5	Normal frequency operating range (see 5.2.2 below)	P
4.6	Harmonics and waveform distortion	P
4.7	Power factor	P
5.2.1	Voltage monitoring	P
5.2.2	Frequency monitoring	P

IEC 62116:2008

Clause	Type Test	Result
6.1	Islanding protection according table 6 - Load imbalance (real, reactive load) for test condition A (EUT output = 100%)	P
6.1	Load imbalance (reactive load) for test condition B (EUT output = 50 % – 66 %)	P
6.1	Load imbalance (reactive load) for test condition C (EUT output = 25 % – 33 %)	P

Deviations for Thailand according the grid-connected inverter regulations of the Provincial Electricity Authority (PEA:2016)

Clause	Type Test	Result
3.4	Reactive power control	
3.4.1, 8.1.2	A fixed displacement factor $\cos\phi$	P
3.4.2, 8.1.2	A variable reactive power depending on the voltage Q(U)	N/A
3.5, 12.1	Active power control	P
3.6, 12.2	Low voltage fault ride through capability	N/A

Test Results

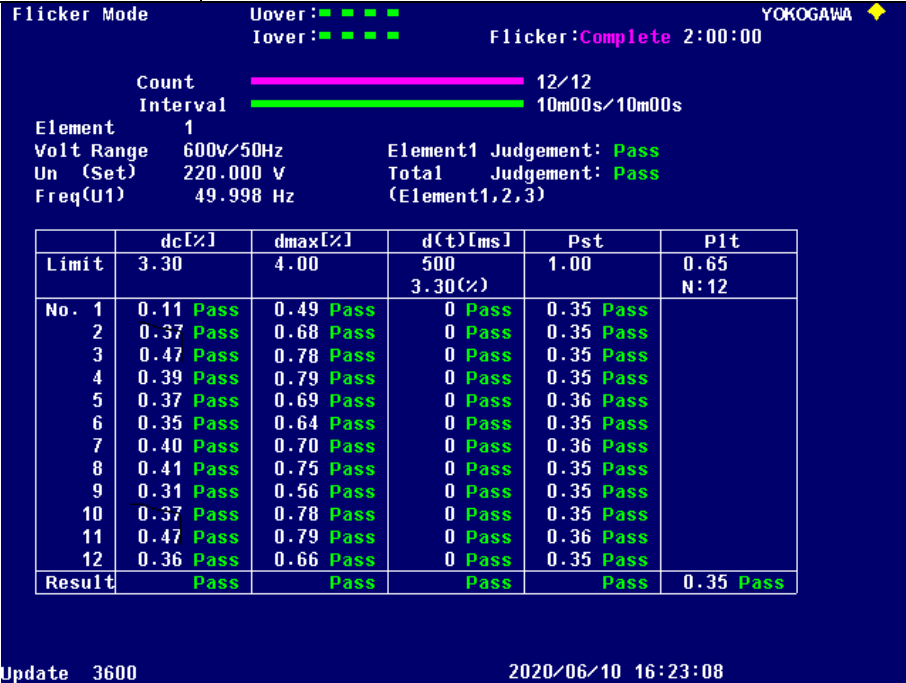
4.3 Voltage fluctuation and flicker 3.2, 8.3 Voltage Fluctuation Regulation (PEA 2016)				P	
Test conditions:		Maximum permissible voltage fluctuation (expressed as a percentage of nominal voltage at 100 % power) and flicker as per EN 61000-3-11			
	Starting	Stopping	Running		
Limit	3,3%	3,3%	P _{st} =1,0	P _{It} =0,65	
Test value	*	*	*	*	
inverter >16A					
Limit	dc% = 3,3		P _{st} =1,0	P _{It} =0,65	
Test value	See below				
					

Flicker Mode Uover: ■■■■ Iover: ■■■■ Flicker: Complete 2:00:00 YOKOGAWA ◆

Count 12/12
Interval 10m00s/10m00s

Element 2
Volt Range 600v/50Hz
Un (Set) 220.000 V
Freq(U2) -----

Element2 Judgement: Pass
Total Judgement: Pass
(Element1,2,3)

	dc[%]	dmax[%]	d(t)[ms]	Pst	P1t
Limit	3.30	4.00	500 3.30(%)	1.00	0.65 N:12
No. 1	0.19 Pass	0.35 Pass	0 Pass	0.22 Pass	
2	0.43 Pass	0.70 Pass	0 Pass	0.22 Pass	
3	0.40 Pass	0.75 Pass	0 Pass	0.22 Pass	
4	0.41 Pass	0.56 Pass	0 Pass	0.22 Pass	
5	0.31 Pass	0.78 Pass	0 Pass	0.22 Pass	
6	0.37 Pass	0.63 Pass	0 Pass	0.21 Pass	
7	0.33 Pass	0.48 Pass	0 Pass	0.22 Pass	
8	0.38 Pass	0.52 Pass	0 Pass	0.22 Pass	
9	0.42 Pass	0.72 Pass	0 Pass	0.22 Pass	
10	0.42 Pass	0.54 Pass	0 Pass	0.23 Pass	
11	0.36 Pass	0.60 Pass	0 Pass	0.21 Pass	
12	0.36 Pass	0.84 Pass	0 Pass	0.22 Pass	
Result	Pass	Pass	Pass	Pass	0.22 Pass

Update 3600 2020/06/10 16:23:24

Flicker Mode Uover: ■■■■ Iover: ■■■■ Flicker: Complete 2:00:00 YOKOGAWA ◆

Count 12/12
Interval 10m00s/10m00s

Element 3
Volt Range 600v/50Hz
Un (Set) 220.000 V
Freq(U3) -----

Element3 Judgement: Pass
Total Judgement: Pass
(Element1,2,3)

	dc[%]	dmax[%]	d(t)[ms]	Pst	P1t
Limit	3.30	4.00	500 3.30(%)	1.00	0.65 N:12
No. 1	0.12 Pass	0.38 Pass	0 Pass	0.23 Pass	
2	0.47 Pass	0.56 Pass	0 Pass	0.23 Pass	
3	0.44 Pass	0.78 Pass	0 Pass	0.23 Pass	
4	0.48 Pass	0.79 Pass	0 Pass	0.23 Pass	
5	0.35 Pass	0.66 Pass	0 Pass	0.23 Pass	
6	0.42 Pass	0.63 Pass	0 Pass	0.23 Pass	
7	0.46 Pass	0.62 Pass	0 Pass	0.23 Pass	
8	0.41 Pass	0.74 Pass	0 Pass	0.23 Pass	
9	0.42 Pass	0.63 Pass	0 Pass	0.23 Pass	
10	0.39 Pass	0.62 Pass	0 Pass	0.22 Pass	
11	0.37 Pass	0.72 Pass	0 Pass	0.23 Pass	
12	0.44 Pass	0.68 Pass	0 Pass	0.23 Pass	
Result	Pass	Pass	Pass	Pass	0.23 Pass

Update 3600 2020/06/10 16:23:41

Note:

*The stationary deviance of dc% is more relevant than the dynamic deviance of d_{max} at starting and stopping.

Mains Impedance according EN61000-3-3: **R_{max} = 0,24Ω; jX_{max} = 0,15Ω @50Hz (|Z_{max}| = 0,283 Ω)**
for single phase inverter use also R_n = 0,16Ω; jX_n = 0,1Ω

Calculation of the maximum permissible grid impedance at the point of common coupling based on dc:
 $Z_{max} = Z_{ref} * 3,3\% / dc(P_n)$

The tests should be based on the limits of the EN 61000-3-3 for less than 16A.

4.4 Monitoring of Permanent DC-Injection 3.3, 8.5 Direct Current Dispatch to the Power Network System (PEA:2016)	P
---	---

PEA Limit:	0,5% of I_{nom} : 76mA		
L1 Output power:	33%	66%	100%
Max. test value (mA):	8	8	9
Mean test value(mA) :	1	1	1
L2 Output power:	33%	66%	100%
Max. test value (mA):	30	32	30
Mean test value(mA) :	24	25	24
L3 Output power:	33%	66%	100%
Max. test value (mA):	5	7	21
Mean test value(mA) :	14	14	13

Diagram of permanent DC-injection

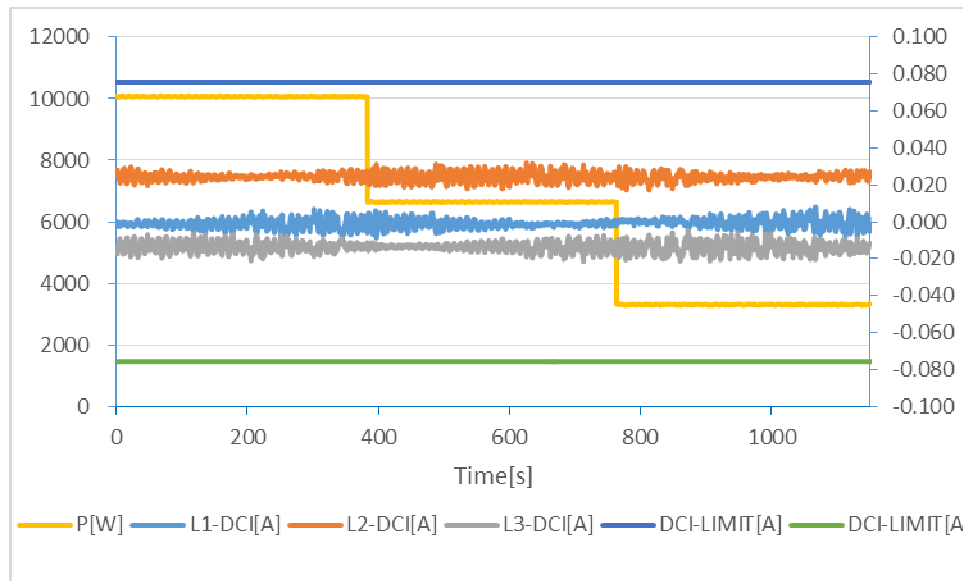

Note:

4.6 Harmonic Current Limit Test the grid-connected inverter regulations of the Provincial Electricity Authority (PEA:2016)								P
33% Output Power								
Watts (W)			1088		1095		1098	
VA (VA)			1091		1100		1097	
Vrms (V)			220,20		220,21		220,26	
Arms (A)			4,953		4,997		4,982	
PF			0,9976		0,9975		0,9983	
Frequency (Hz)			50,00					
THD50 (%)			1,007		0,887		0,895	
Harmonics	Current Magnitude [A]			% of Rated Current			Phase	Harmonic Current Limits [%]
1st	4,941	4,985	4,973	0,326	0,329	0,328	Three Phase	--
2nd	0,009	0,014	0,010	0,060	0,090	0,067	Three Phase	1
3rd	0,016	0,016	0,030	0,109	0,105	0,198	Three Phase	4
4th	0,005	0,005	0,004	0,035	0,033	0,028	Three Phase	1
5th	0,085	0,062	0,068	0,561	0,407	0,446	Three Phase	4
6th	0,004	0,008	0,009	0,029	0,050	0,062	Three Phase	1
7th	0,023	0,020	0,013	0,154	0,133	0,083	Three Phase	4
8th	0,009	0,007	0,009	0,060	0,044	0,057	Three Phase	1
9th	0,022	0,013	0,029	0,143	0,087	0,190	Three Phase	4
10th	0,007	0,005	0,007	0,049	0,033	0,043	Three Phase	1
11th	0,050	0,041	0,032	0,332	0,271	0,212	Three Phase	2
12th	0,003	0,008	0,007	0,022	0,052	0,047	Three Phase	0,5
13th	0,072	0,066	0,064	0,478	0,437	0,424	Three Phase	2
14th	0,007	0,004	0,006	0,049	0,028	0,039	Three Phase	0,5
15th	0,013	0,009	0,020	0,086	0,060	0,131	Three Phase	2
16th	0,005	0,004	0,006	0,032	0,023	0,037	Three Phase	0,5
17th	0,014	0,031	0,025	0,095	0,202	0,164	Three Phase	1,5
18th	0,003	0,005	0,003	0,021	0,032	0,019	Three Phase	0,375
19th	0,048	0,039	0,040	0,314	0,259	0,263	Three Phase	1,5
20th	0,004	0,002	0,004	0,029	0,015	0,027	Three Phase	0,375
21th	0,005	0,004	0,008	0,035	0,026	0,054	Three Phase	1,5
22th	0,004	0,002	0,005	0,023	0,016	0,030	Three Phase	0,375
23th	0,022	0,029	0,020	0,145	0,194	0,134	Three Phase	0,6
24th	0,003	0,002	0,002	0,020	0,016	0,013	Three Phase	0,15
25th	0,019	0,014	0,017	0,126	0,095	0,114	Three Phase	0,6
26th	0,003	0,002	0,002	0,019	0,016	0,015	Three Phase	0,15
27th	0,008	0,004	0,008	0,051	0,025	0,054	Three Phase	0,6
28th	0,003	0,003	0,004	0,021	0,018	0,026	Three Phase	0,15
29th	0,032	0,031	0,026	0,208	0,208	0,173	Three Phase	0,6
30th	0,002	0,002	0,003	0,015	0,016	0,017	Three Phase	0,15
31th	0,010	0,010	0,010	0,065	0,067	0,065	Three Phase	0,6
32th	0,003	0,003	0,002	0,017	0,017	0,016	Three Phase	0,15
33th	0,005	0,005	0,007	0,033	0,033	0,049	Three Phase	0,6
34th	0,004	0,002	0,004	0,026	0,010	0,027	Three Phase	0,15
35th	0,015	0,020	0,018	0,102	0,132	0,121	Three Phase	0,3



36th	0,003	0,002	0,003	0,020	0,011	0,018	Three Phase	0,075
37th	0,007	0,004	0,007	0,048	0,027	0,043	Three Phase	0,3
38th	0,003	0,003	0,002	0,022	0,017	0,012	Three Phase	0,075
39th	0,007	0,007	0,010	0,045	0,044	0,064	Three Phase	0,3
40th	0,003	0,002	0,002	0,017	0,011	0,015	Three Phase	0,075
41th	0,011	0,009	0,009	0,071	0,063	0,059	Three Phase	N/A
42th	0,003	0,002	0,002	0,017	0,014	0,011	Three Phase	N/A
43th	0,012	0,016	0,017	0,079	0,108	0,109	Three Phase	N/A
44th	0,004	0,003	0,003	0,027	0,018	0,020	Three Phase	N/A
45th	0,007	0,006	0,005	0,043	0,038	0,036	Three Phase	N/A
46th	0,009	0,010	0,008	0,061	0,063	0,054	Three Phase	N/A
47th	0,028	0,029	0,026	0,182	0,192	0,168	Three Phase	N/A
48th	0,011	0,010	0,008	0,070	0,066	0,056	Three Phase	N/A
49th	0,012	0,013	0,015	0,079	0,086	0,101	Three Phase	N/A
50th	0,004	0,002	0,004	0,026	0,016	0,026	Three Phase	N/A

66% Output Power			
Watts (W)	2200	2207	2204
VA (VA)	2201	2208	2205
Vrms (V)	220,41	220,37	220,45
Arms (A)	9,987	10,020	10,004
PF	0,9994	0,9994	0,9997
Frequency (Hz)	50		
THD50 (%)	0,863	0,802	0,802

Harmonics	Current Magnitude [A]			% of Rated Current			Phase	Harmonic Current Limits [%]
	9,982	10,015	10,000	0,659	0,661	0,660		
1st	9,982	10,015	10,000	0,659	0,661	0,660	Three Phase	--
2nd	0,012	0,010	0,008	0,078	0,064	0,051	Three Phase	1
3rd	0,012	0,013	0,022	0,076	0,084	0,146	Three Phase	4
4th	0,005	0,006	0,003	0,035	0,041	0,023	Three Phase	1
5th	0,063	0,054	0,058	0,416	0,355	0,382	Three Phase	4
6th	0,005	0,004	0,006	0,032	0,026	0,041	Three Phase	1
7th	0,015	0,017	0,014	0,099	0,112	0,090	Three Phase	4
8th	0,006	0,004	0,006	0,040	0,026	0,040	Three Phase	1
9th	0,012	0,008	0,015	0,080	0,055	0,102	Three Phase	4
10th	0,006	0,004	0,004	0,039	0,029	0,029	Three Phase	1
11th	0,039	0,030	0,033	0,258	0,198	0,220	Three Phase	2
12th	0,003	0,003	0,004	0,018	0,023	0,029	Three Phase	0,5
13th	0,046	0,042	0,041	0,301	0,275	0,273	Three Phase	2
14th	0,006	0,003	0,005	0,042	0,019	0,034	Three Phase	0,5
15th	0,008	0,006	0,012	0,050	0,040	0,078	Three Phase	2
16th	0,004	0,003	0,003	0,029	0,021	0,017	Three Phase	0,5
17th	0,025	0,024	0,018	0,165	0,157	0,118	Three Phase	1,5
18th	0,002	0,002	0,003	0,012	0,015	0,018	Three Phase	0,375
19th	0,044	0,040	0,039	0,290	0,267	0,254	Three Phase	1,5
20th	0,005	0,002	0,004	0,030	0,013	0,023	Three Phase	0,375
21th	0,004	0,004	0,007	0,024	0,024	0,043	Three Phase	1,5
22th	0,003	0,002	0,002	0,022	0,016	0,015	Three Phase	0,375



23th	0,044	0,044	0,040	0,289	0,292	0,261	Three Phase	0,6
24th	0,002	0,001	0,002	0,010	0,009	0,011	Three Phase	0,15
25th	0,014	0,011	0,012	0,090	0,071	0,079	Three Phase	0,6
26th	0,003	0,002	0,002	0,018	0,012	0,015	Three Phase	0,15
27th	0,005	0,003	0,005	0,031	0,019	0,030	Three Phase	0,6
28th	0,003	0,002	0,002	0,017	0,013	0,011	Three Phase	0,15
29th	0,035	0,035	0,032	0,232	0,229	0,211	Three Phase	0,6
30th	0,002	0,002	0,002	0,012	0,011	0,012	Three Phase	0,15
31th	0,028	0,026	0,027	0,182	0,169	0,178	Three Phase	0,6
32th	0,002	0,002	0,002	0,010	0,011	0,012	Three Phase	0,15
33th	0,007	0,005	0,007	0,049	0,034	0,045	Three Phase	0,6
34th	0,002	0,001	0,002	0,016	0,010	0,013	Three Phase	0,15
35th	0,016	0,021	0,019	0,105	0,137	0,123	Three Phase	0,3
36th	0,002	0,002	0,002	0,013	0,010	0,013	Three Phase	0,075
37th	0,011	0,011	0,010	0,073	0,070	0,064	Three Phase	0,3
38th	0,002	0,002	0,002	0,011	0,011	0,011	Three Phase	0,075
39th	0,009	0,011	0,008	0,059	0,072	0,051	Three Phase	0,3
40th	0,002	0,002	0,002	0,014	0,011	0,011	Three Phase	0,075
41th	0,010	0,012	0,011	0,069	0,080	0,070	Three Phase	N/A
42th	0,002	0,002	0,002	0,014	0,010	0,012	Three Phase	N/A
43th	0,015	0,019	0,018	0,100	0,124	0,117	Three Phase	N/A
44th	0,002	0,002	0,002	0,011	0,011	0,011	Three Phase	N/A
45th	0,005	0,004	0,005	0,032	0,029	0,034	Three Phase	N/A
46th	0,010	0,009	0,008	0,063	0,061	0,052	Three Phase	N/A
47th	0,026	0,028	0,026	0,173	0,184	0,168	Three Phase	N/A
48th	0,010	0,009	0,009	0,068	0,061	0,056	Three Phase	N/A
49th	0,009	0,010	0,011	0,062	0,065	0,071	Three Phase	N/A
50th	0,002	0,002	0,002	0,012	0,010	0,012	Three Phase	N/A

100% Output Power								
Watts (kW)				3336		3325		3327
VA (kVA)				3338		3326		3328
Vrms (V)				220,76		220,76		220,68
Arms (A)				15,121		15,070		15,081
PF				0,9997		0,9996		0,9997
Frequency (Hz)				50,00				
THD50 (%)				1,514		1,514		1,459
Harmonics	Current Magnitude [A]			% of Rated Current			Phase	Harmonic Current Limits [%]
1st	15,144	15,178	15,162	0,999	1,002	1,001	Three Phase	--
2nd	0,011	0,008	0,006	0,070	0,055	0,042	Three Phase	1
3rd	0,010	0,013	0,020	0,063	0,088	0,132	Three Phase	4
4th	0,006	0,007	0,003	0,037	0,044	0,023	Three Phase	1
5th	0,059	0,051	0,054	0,393	0,336	0,356	Three Phase	4
6th	0,004	0,004	0,005	0,029	0,024	0,035	Three Phase	1
7th	0,012	0,014	0,014	0,078	0,094	0,090	Three Phase	4
8th	0,005	0,004	0,005	0,036	0,026	0,034	Three Phase	1



9th	0,013	0,009	0,013	0,083	0,056	0,085	Three Phase	4
10th	0,005	0,004	0,004	0,036	0,028	0,027	Three Phase	1
11th	0,041	0,032	0,036	0,269	0,213	0,239	Three Phase	2
12th	0,003	0,004	0,004	0,017	0,026	0,028	Three Phase	0,5
13th	0,036	0,035	0,034	0,237	0,233	0,225	Three Phase	2
14th	0,005	0,003	0,004	0,033	0,019	0,024	Three Phase	0,5
15th	0,009	0,007	0,012	0,058	0,048	0,077	Three Phase	2
16th	0,004	0,003	0,003	0,027	0,019	0,019	Three Phase	0,5
17th	0,012	0,008	0,008	0,077	0,054	0,054	Three Phase	1,5
18th	0,002	0,003	0,003	0,012	0,022	0,021	Three Phase	0,375
19th	0,028	0,027	0,025	0,182	0,179	0,165	Three Phase	1,5
20th	0,004	0,002	0,002	0,025	0,016	0,016	Three Phase	0,375
21th	0,004	0,004	0,008	0,030	0,025	0,055	Three Phase	1,5
22th	0,003	0,002	0,002	0,019	0,016	0,015	Three Phase	0,375
23th	0,024	0,024	0,022	0,161	0,156	0,146	Three Phase	0,6
24th	0,002	0,002	0,002	0,010	0,012	0,012	Three Phase	0,15
25th	0,013	0,012	0,013	0,085	0,079	0,083	Three Phase	0,6
26th	0,002	0,002	0,002	0,015	0,012	0,013	Three Phase	0,15
27th	0,007	0,002	0,006	0,048	0,016	0,039	Three Phase	0,6
28th	0,002	0,002	0,002	0,010	0,013	0,010	Three Phase	0,15
29th	0,022	0,021	0,021	0,142	0,139	0,141	Three Phase	0,6
30th	0,002	0,001	0,001	0,011	0,010	0,010	Three Phase	0,15
31th	0,036	0,035	0,034	0,239	0,232	0,223	Three Phase	0,6
32th	0,001	0,001	0,002	0,009	0,009	0,011	Three Phase	0,15
33th	0,009	0,004	0,008	0,058	0,024	0,054	Three Phase	0,6
34th	0,002	0,001	0,001	0,010	0,009	0,009	Three Phase	0,15
35th	0,009	0,007	0,009	0,062	0,045	0,059	Three Phase	0,3
36th	0,002	0,002	0,002	0,012	0,011	0,011	Three Phase	0,075
37th	0,017	0,016	0,013	0,112	0,108	0,089	Three Phase	0,3
38th	0,002	0,002	0,002	0,013	0,010	0,012	Three Phase	0,075
39th	0,007	0,010	0,005	0,045	0,066	0,031	Three Phase	0,3
40th	0,002	0,002	0,002	0,012	0,013	0,012	Three Phase	0,075
41th	0,011	0,010	0,012	0,073	0,068	0,080	Three Phase	N/A
42th	0,002	0,002	0,002	0,013	0,011	0,011	Three Phase	N/A
43th	0,021	0,025	0,021	0,139	0,165	0,135	Three Phase	N/A
44th	0,002	0,002	0,002	0,012	0,012	0,011	Three Phase	N/A
45th	0,005	0,004	0,004	0,032	0,028	0,026	Three Phase	N/A
46th	0,009	0,009	0,008	0,059	0,057	0,051	Three Phase	N/A
47th	0,028	0,027	0,026	0,182	0,180	0,169	Three Phase	N/A
48th	0,010	0,009	0,008	0,063	0,061	0,054	Three Phase	N/A
49th	0,009	0,009	0,007	0,062	0,062	0,046	Three Phase	N/A
50th	0,002	0,002	0,002	0,013	0,012	0,011	Three Phase	N/A

Note: The harmonics are tested and evaluated according the IEEE1547.1-2005 clause 5.11.1 according the grid-connected inverter regulations of the Provincial Electricity Authority (PEA:2016).

4.6 Harmonic Voltage Limit Test the grid-connected inverter regulations of the Provincial Electricity Authority (PEA:2016)								P
Vrms (V)				220,005		220,922		220,822
Frequency (Hz)				50,00				
THD50 (%)				1,199		1,333		1,327
Harmonics	Voltage Magnitude [V]			% of Rated Voltage			Phase	Limits [%]
2nd	0,113	0,134	0,227	0,051	0,061	0,103	Three Phase	0,2
3rd	2,424	2,696	2,660	1,102	1,226	1,209	Three Phase	4
4th	0,124	0,148	0,101	0,056	0,067	0,046	Three Phase	0,2
5th	0,599	0,701	0,739	0,272	0,318	0,336	Three Phase	4
6th	0,081	0,093	0,083	0,037	0,042	0,038	Three Phase	0,2
7th	0,501	0,573	0,594	0,228	0,260	0,270	Three Phase	4
8th	0,075	0,078	0,074	0,034	0,036	0,034	Three Phase	0,2
9th	0,274	0,329	0,371	0,124	0,149	0,168	Three Phase	2
10th	0,070	0,054	0,058	0,032	0,024	0,027	Three Phase	0,2
11th	0,210	0,204	0,191	0,095	0,093	0,087	Three Phase	0,1
12th	0,060	0,064	0,055	0,027	0,029	0,025	Three Phase	0,1
13th	0,208	0,197	0,198	0,094	0,090	0,090	Three Phase	0,1
14th	0,056	0,058	0,053	0,025	0,026	0,024	Three Phase	0,1
15th	0,089	0,109	0,131	0,041	0,050	0,059	Three Phase	0,1
16th	0,066	0,070	0,058	0,030	0,032	0,026	Three Phase	0,1
17th	0,111	0,146	0,150	0,051	0,066	0,068	Three Phase	0,1
18th	0,050	0,054	0,046	0,023	0,024	0,021	Three Phase	0,1
19th	0,123	0,135	0,150	0,056	0,061	0,068	Three Phase	0,1
20th	0,039	0,041	0,040	0,018	0,019	0,018	Three Phase	0,1
21th	0,055	0,044	0,060	0,025	0,020	0,027	Three Phase	0,1
22th	0,039	0,041	0,039	0,018	0,019	0,018	Three Phase	0,1
23th	0,089	0,105	0,101	0,040	0,048	0,046	Three Phase	0,1
24th	0,036	0,044	0,036	0,016	0,020	0,016	Three Phase	0,1
25th	0,084	0,082	0,083	0,038	0,037	0,038	Three Phase	0,1
26th	0,036	0,040	0,039	0,016	0,018	0,018	Three Phase	0,1
27th	0,050	0,053	0,041	0,023	0,024	0,019	Three Phase	0,1
28th	0,040	0,041	0,036	0,018	0,019	0,016	Three Phase	0,1
29th	0,102	0,099	0,099	0,046	0,045	0,045	Three Phase	0,1
30th	0,041	0,040	0,044	0,019	0,018	0,020	Three Phase	0,1
31th	0,154	0,177	0,155	0,070	0,080	0,070	Three Phase	0,1
32th	0,045	0,047	0,043	0,021	0,021	0,020	Three Phase	0,1
33th	0,075	0,051	0,049	0,034	0,023	0,022	Three Phase	0,1
34th	0,060	0,058	0,048	0,027	0,027	0,022	Three Phase	0,1
35th	0,160	0,177	0,168	0,073	0,080	0,077	Three Phase	0,1
36th	0,065	0,071	0,076	0,030	0,032	0,034	Three Phase	0,1
37th	0,193	0,181	0,177	0,088	0,082	0,080	Three Phase	0,1
38th	0,170	0,165	0,160	0,077	0,075	0,073	Three Phase	0,1
39th	0,175	0,081	0,124	0,080	0,037	0,056	Three Phase	0,1
40th	0,121	0,133	0,105	0,055	0,061	0,048	Three Phase	0,1

Note: The harmonics are tested and evaluated according the IEEE1547.1-2005 clause 5.11.1 according the grid-connected inverter regulations of the Provincial Electricity Authority (PEA:2016).

4.7 Power factor(PEA) 3.1, 8.4 Harmonic Regulation (PEA: 2016)					P
Test conditions:					
Output power [kW]	~10%	~25%	~50%	~75%	~100%
Test AC voltage [V]					
220	0,9926	0,9995	0,9999	0,9999	0,9999
<p>Note: The PV system shall have a lagging power factor greater than 0,95 when the output is greater than 50% of the rated inverter output power.</p> <p>The letter “i” is short for “inductive” and indicates inductive power factor. In case of capacitive power factor the letter “c” is used instead.</p> <p>Test result refer to table 3.4.1, 8.1.2 1.</p>					

5.2.1 Voltage monitoring 3.7, 12.3 Under and Over Voltage Protection (PEA:2016) 3.10, 12.5 Response to utility recovery (PEA:2016)										P
First Level (Phase to Neutral)										
Test conditions:	Output power: 10KW Frequency: 50Hz									
	Under Voltage					Over Voltage				
	Voltage [V]					Voltage [V]				
Set value	198V					242V				
Measured trip value		All	L1	L2	L3		All	L1	L2	L3
		197,8	197,8	197,7	197,9		242,3	243,0	242,5	243,2
		197,8	197,7	197,9	197,7		242,3	243,6	242,6	242,7
		197,8	197,9	197,8	197,8		242,3	243,1	242,3	242,1
Parameter		Time [s]					Time [s]			
Limit		<= 2,0s					<= 1,0s			
Disconnection time	220V to 203V (4s min) to 193V	All	L1	L2	L3	220V to 237V (2s min) to 247V	All	L1	L2	L3
		1,68	1,62	1,64	1,62		0,64	0,63	0,64	0,62
		1,66	1,64	1,64	1,62		0,64	0,62	0,64	0,62
		1,66	1,64	1,64	1,64		0,64	0,64	0,63	0,63
Reconnection time	20s - 5min	62s				20s - 5min	63s			

Second Level (Phase to Neutral)										
Test conditions:	Output power:10KW Frequency: 50Hz									
	Under Voltage					Over Voltage				
Parameter		Voltage [V]					Voltage [V]			
Set value		110V					264V			
Measured trip value		All	L1	L2	L3		All	L1	L2	L3
		109,0	109,7	109,3	109,7		264,2	265,2	265,0	265,0
		109,5	109,4	109,5	109,7		264,1	265,3	265,1	265,3
		109,8	109,4	109,7	109,6		264,1	265,2	264,9	265,0
Parameter		Time [ms]					Time [ms]			
Limit		<= 300ms					<= 160ms			
Disconnection time	220V to 203V (0.6s min) to 105V	All	L1	L2	L3	220V to 237V (0.32s min) to 269V	All	L1	L2	L3
		188	206	192	194		80	78	80	82
		190	204	192	190		82	78	76	80
		192	198	210	210		80	78	72	80
Reconnection time	20s - 5min	60s				20s - 5min	62s			
<p>Note: Note: The tests are according PEA 8/9/2556. The voltage settings of the EUT are set for the tests as stated to 198V, 110V for undervoltage and 242V, 264V for overvoltage. Response to utility recovery is according to the appropriate IEEE or IEC standard test methods.</p>										

Under Voltage First Level

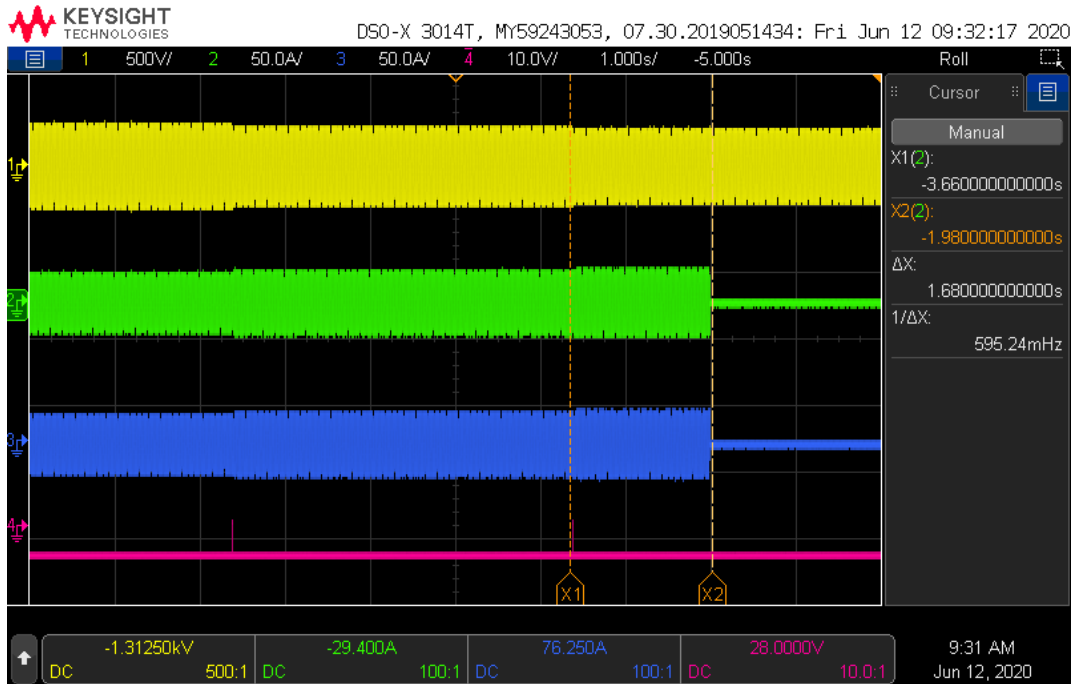

Over voltage First Level

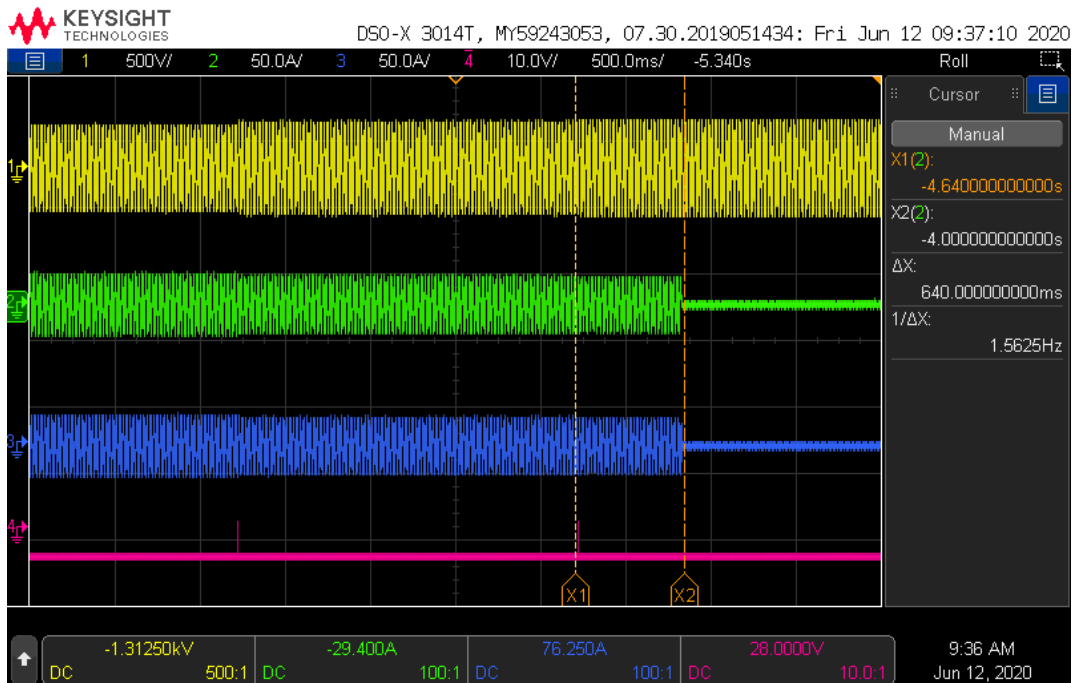

Note: CH1: grid voltage(300V/div); CH2: Current of EUT(15A/div); CH3: Current of EUT(15A/div)

Under Voltage Second Level

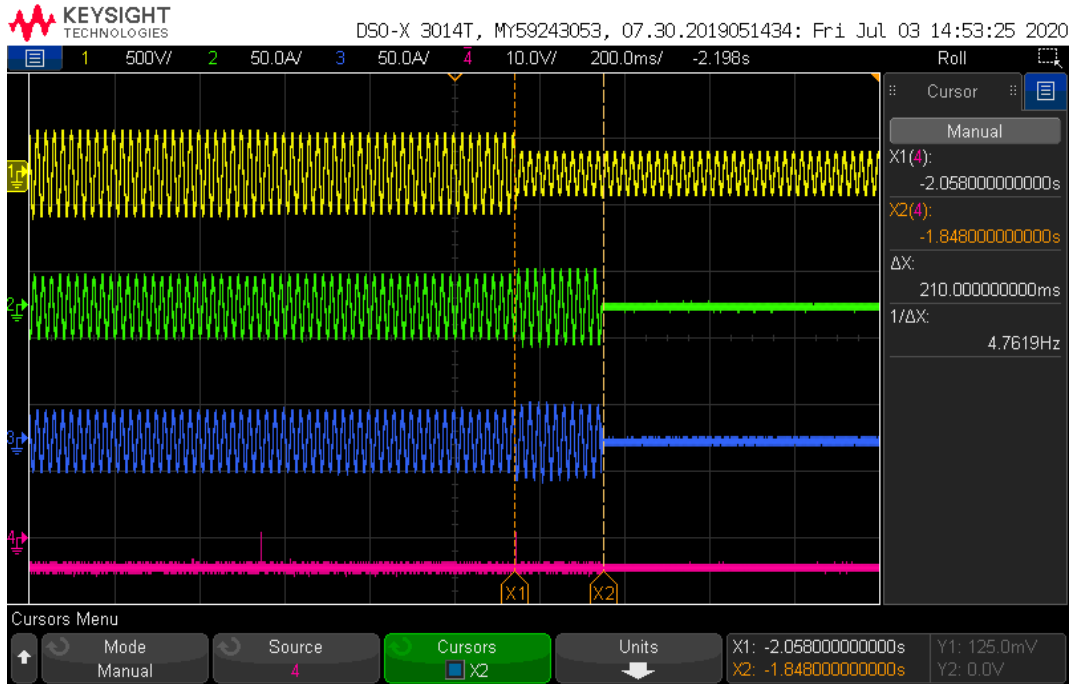

Over voltage Second Level

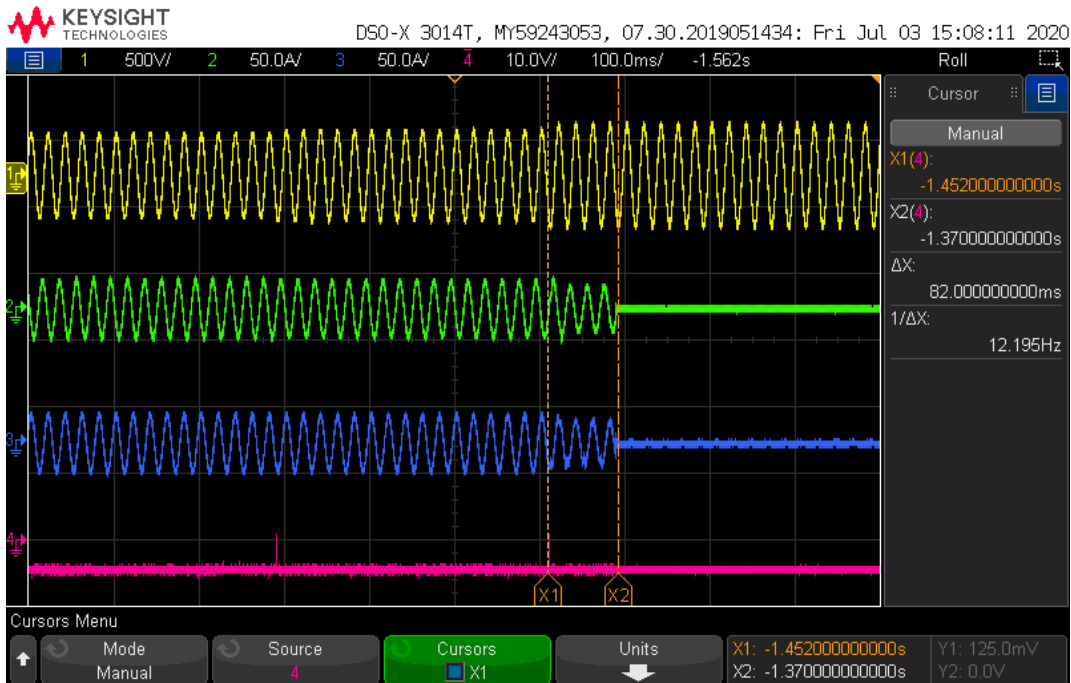

Note: CH1: grid voltage(300V/div); CH2: Current of EUT(15A/div); CH3: Current of EUT(15A/div)

Reconnection after Under Voltage First Level

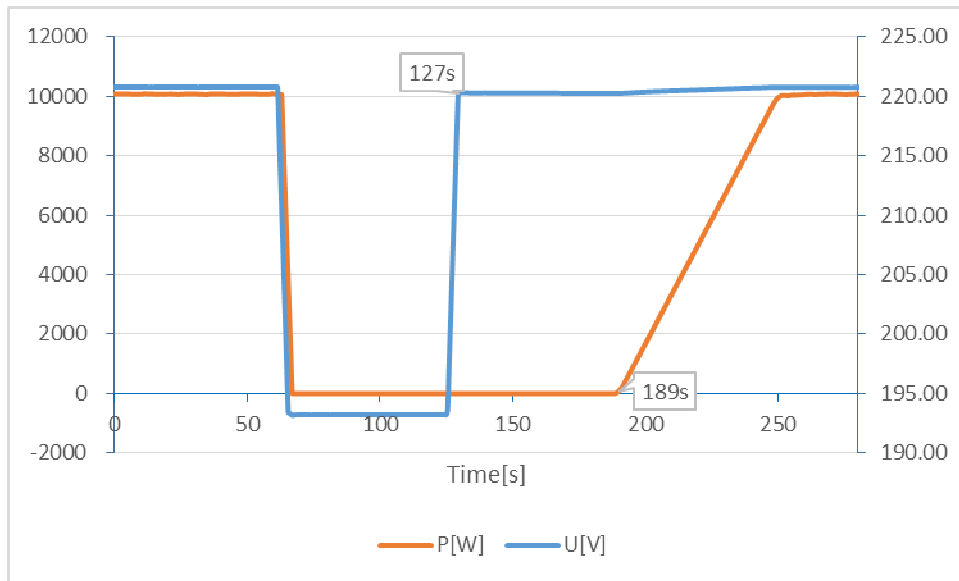

Reconnection after Over Voltage First Level

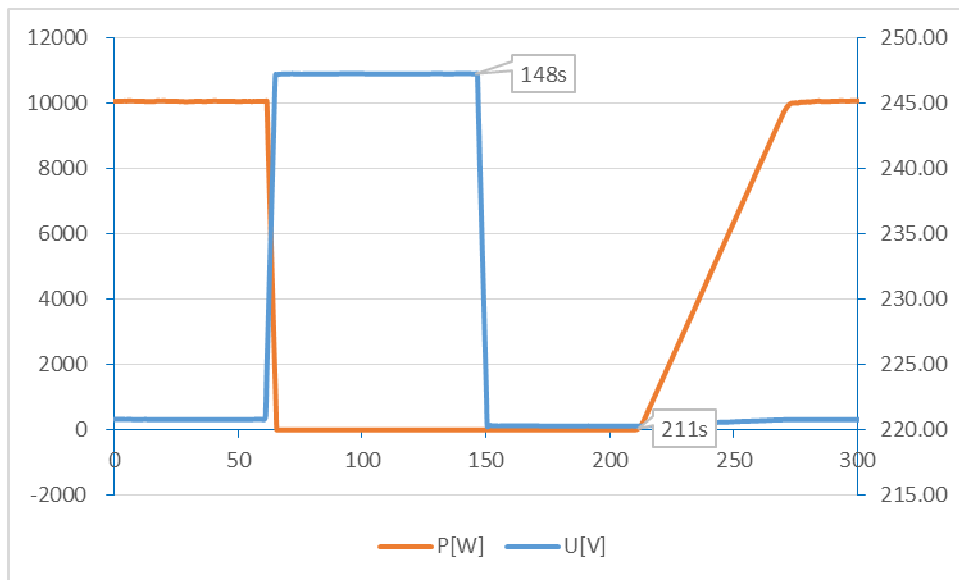

Reconnection after Under Voltage Second Level

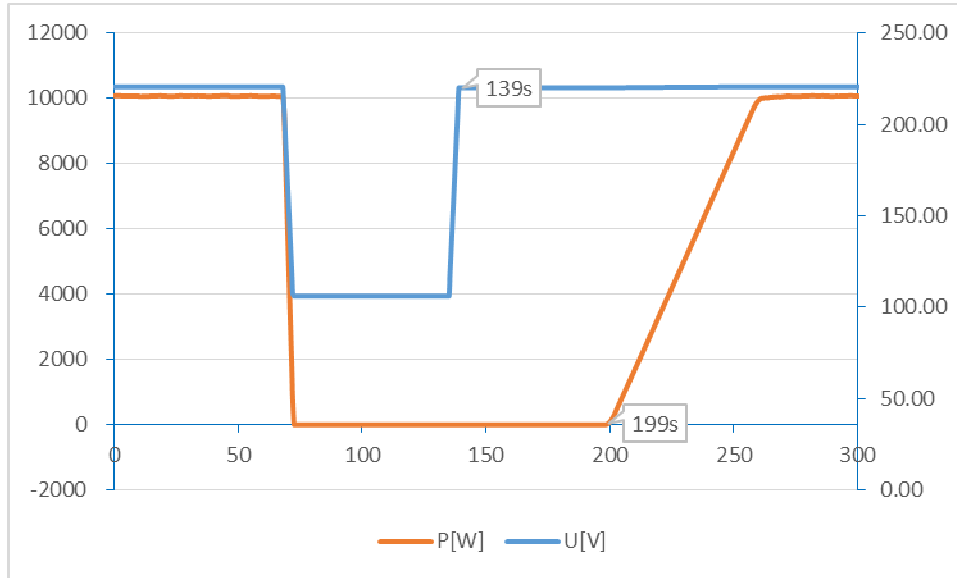

Reconnection after Over Voltage Second Level

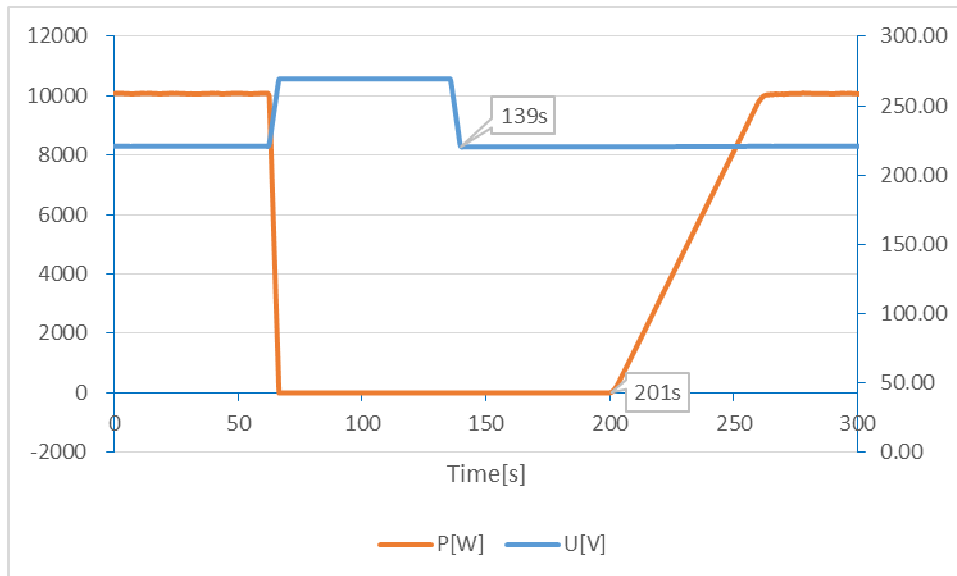

5.2.2 Frequency monitoring				P
IEC 61727 8.2 Under and Over Frequency Protection (PEA:2016) 3.10, 12.5 Response to utility recovery (PEA:2016)				
Test conditions:	Any output power level			
	Under frequency		Over frequency	
Parameter		Frequency [Hz]		Frequency [Hz]
Output Voltage		U_N		U_N
Set value		47,00Hz		52,00Hz
Measured trip value(V)		46,98		52,01
		Time [ms]		Time [ms]
Limit		<= 100ms		<= 100ms
Disconnection time(ms)	50,0Hz to 47,2 Hz (0,2s min) to 46,5 Hz	92	50,0 Hz to 51,80 Hz (0,2s min) to 52,5Hz	92
Reconnection time (Sec)	20s – 5min	63s	20s-5min	63s
Note: The frequency which inverter stops feeding power to electrical system in each test must be in the range of the frequency trip setting +/- 0,1Hz and the time it takes to cut off the power must be within 0.1 second. The tests are performed according the IEEE 1547.1-2005, annex A. Response to utility recovery is according to the appropriate IEEE or IEC standard test methods.				

Under Frequency:

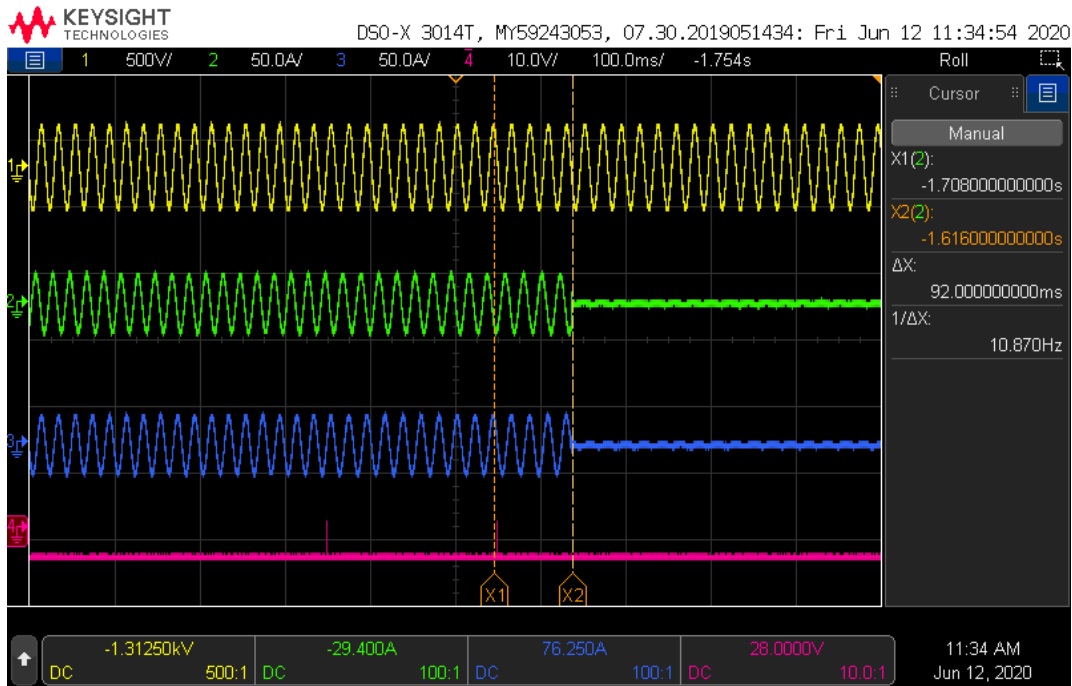

Over Frequency:

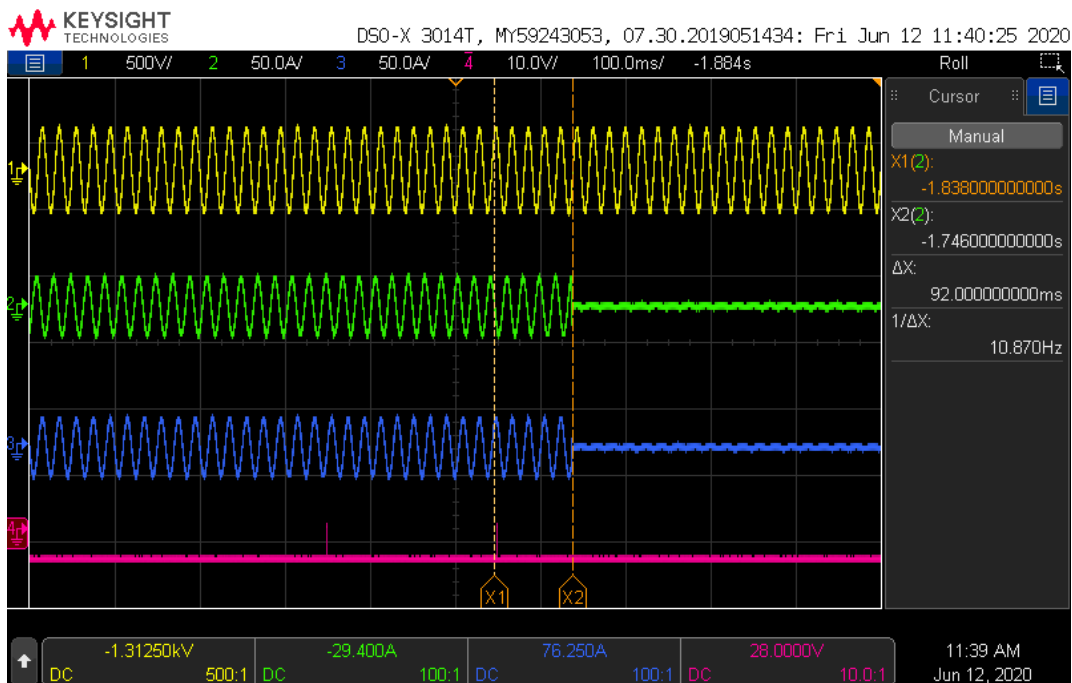

Note:

CH1: grid voltage(300V/div); CH2: Current of EUT(15A/div); CH3: Current of EUT(15A/div) CH4: trip signal

6.1 Islanding protection
3.9, 12.4 Anti-Islanding (PEA:2016)

Test circuit and parameters

Parameter	Symbol	Units
EUT DC Input		
DC voltage	V_{DC}	V
DC Current	I_{DC}	A
DC Power	P_{DC}	W
EUT AC output		
AC voltage	V_{EUT}	V
AC current	I_{EUT}	A
Real power	P_{EUT}	W
Reactive power	Q_{EUT}	VAR
Test Load		
Resistive load current	I_R	A
Inductive load current	I_L	A
Capacitive load current	I_C	A
AC (utility) power source		
Utility real power	P_{AC}	W
Utility reactive power	Q_{AC}	VAR
Utility current	I_{AC}	A

Block diagram test circuit IEC 62116:2008

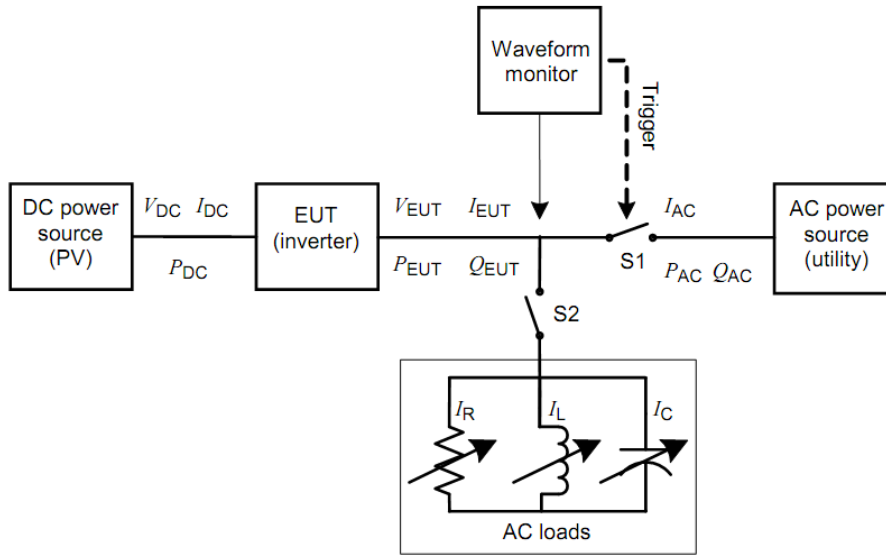

IEC 1567/08

Figure 1 – Test circuit for islanding detection function in a power conditioner (inverter)

6.1 Islanding protection according table 6 - Load imbalance (real, reactive load) for test condition A (EUT output = 100%) 3.9, 12.4 Anti-Islanding (PEA:2016)									P
Test conditions		Frequency: 50+/-0,1Hz U _N =220+/-3Vac Distortion factor of chokes < 2% Quality = 1							
Disconnection limit		1s							
No	P _{EUT} ¹⁾ (% of EUT rating)	Reactive load (% of Q _L in 6.1.d) 1)	P _{AC} ²⁾ (% of nominal)	Q _{AC} ³⁾ (% of nominal)	Run on Time (ms)	P _{EUT} (W per phase)	Actual Q _f	V _{DC} (V)	Remarks ⁴⁾
1	100	100	0	0	524	3333	1,001	745	Test A at BL
4	100	100	-5	-5	380	3333	1,027	745	Test A at IB
5	100	100	-5	0	436	3333	1,054	745	Test A at IB
6	100	100	-5	+5	490	3333	1,080	745	Test A at IB
7	100	100	0	-5	482	3333	0,976	745	Test A at IB
8	100	100	0	+5	416	3333	1,026	745	Test A at IB
9	100	100	+5	-5	408	3333	0,929	745	Test A at IB
10	100	100	+5	0	484	3333	0,953	745	Test A at IB
11	100	100	+5	+5	402	3333	0,977	745	Test A at IB
Parameter at 0% per phase		L= 50,45mH		R= 15,87Ω		C= 200,67μF			
IAC fundamental current(A)		102 mA							
<p>Note: RLC is adjusted to min. +/-1% of the inverter rated output power 1) P_{EUT}: EUT output power 2) P_{AC}: Real power flow at S1 in Figure 1. Positive means power from EUT to utility. Nominal is the 0 % test condition value. 3) Q_{AC}: Reactive power flow at S1 in Figure 1. Positive means power from EUT to utility. Nominal is the 0 % test condition value. 4) BL: Balance condition, IB: Imbalance condition.</p> <p>Condition A: EUT output power P_{EUT} = Maximum ⁵⁾ EUT input voltage ⁶⁾ = >90% of rated input voltage range</p> <p>⁵⁾ Maximum EUT output power condition should be achieved using the maximum allowable input power. Actual output power may exceed nominal rated output. ⁶⁾ Based on EUT rated input operating range. For example, If range is between X volts and Y volts, 90 % of range = X + 0,9 × (Y – X). Y shall not exceed 0,8 × EUT maximum system voltage (i.e., maximum allowable array open circuit voltage). In any case, the EUT should not be operated outside of its allowable input voltage range.</p>									

Disconnection at P_{AC} 0% and Q_{AC} 0% reactive load No. 1

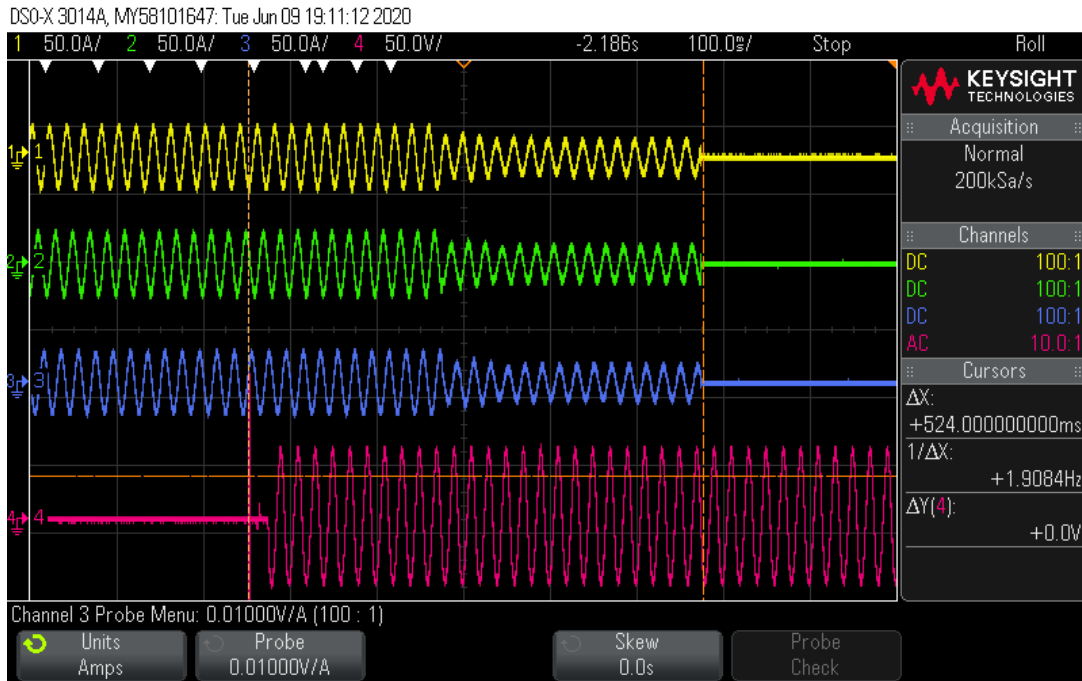

Attention:

For Thailand only picture with all three current phases L1, L2 and L3 are accepted.

All relays are direct coupled and open directly by receiving the islanding signal from the controller.

Note:

CH1,CH2,CH3: Current of EUT(20A/div); CH4: trip signal

6.1 Islanding protection according Table 7 – Load imbalance (reactive load) for test condition B (EUT output = 50 % – 66 %) 3.9, 12.4 Anti-Islanding (PEA:2016)									P
Test conditions		Frequency: 50+/-0,1Hz U _N =220+/-3Vac Distortion factor of chokes < 2% Quality =1							
Disconnection limit		1s							
No	P _{EUT} ¹⁾ (% of EUT rating)	Reactive load (% of Q _L in 6.1.d) 1)	P _{AC} ²⁾ (% of nominal)	Q _{AC} ³⁾ (% of nominal)	Run on Time (ms)	P _{EUT} (W per phase)	Actual Qf	V _{DC} (V)	Remarks ⁴⁾
1	66	66	0	-5	420	2200	0,976	525	Test B at IB
2	66	66	0	-4	482	2200	0,981	525	Test B at IB
3	66	66	0	-3	490	2200	0,986	525	Test B at IB
4	66	66	0	-2	474	2200	0,991	525	Test B at IB
5	66	66	0	-1	446	2200	0,996	525	Test B at IB
6	66	66	0	0	530	2200	1,001	525	Test B at BL
7	66	66	0	1	432	2200	1,006	525	Test B at IB
8	66	66	0	2	394	2200	1,011	525	Test B at IB
9	66	66	0	3	380	2200	1,016	525	Test B at IB
10	66	66	0	4	412	2200	1,021	525	Test B at IB
11	66	66	0	5	330	2200	1,026	525	Test B at IB
Parameter at 0% per phase			L= 76,19mH		R= 23,97Ω		C= 132,98μF		
IAC fundamental current(A)			98 mA						
<p>Note: RLC is adjusted to min. +/-1% of the inverter rated output power 1) P_{EUT}: EUT output power 2) P_{AC}: Real power flow at S1 in Figure 1. Positive means power from EUT to utility. Nominal is the 0 % test condition value. 3) Q_{AC}: Reactive power flow at S1 in Figure 1. Positive means power from EUT to utility. Nominal is the 0 % test condition value. 4) BL: Balance condition, IB: Imbalance condition. Condition B: EUT output power P_{EUT} = 50 % – 66 % of maximum EUT input voltage⁵⁾ = 50 % of rated input voltage range, ±10 % 5) Based on EUT rated input operating range. For example, If range is between X volts and Y volts, 50 % of range = X + 0,5 × (Y – X). Y shall not exceed 0,8 × EUT maximum system voltage (i.e., maximum allowable array open circuit voltage). In any case, the EUT should not be operated outside of its allowable input voltage range.</p>									

Disconnection at P_{AC} 0% and Q_{AC} +0% reactive load No. 6

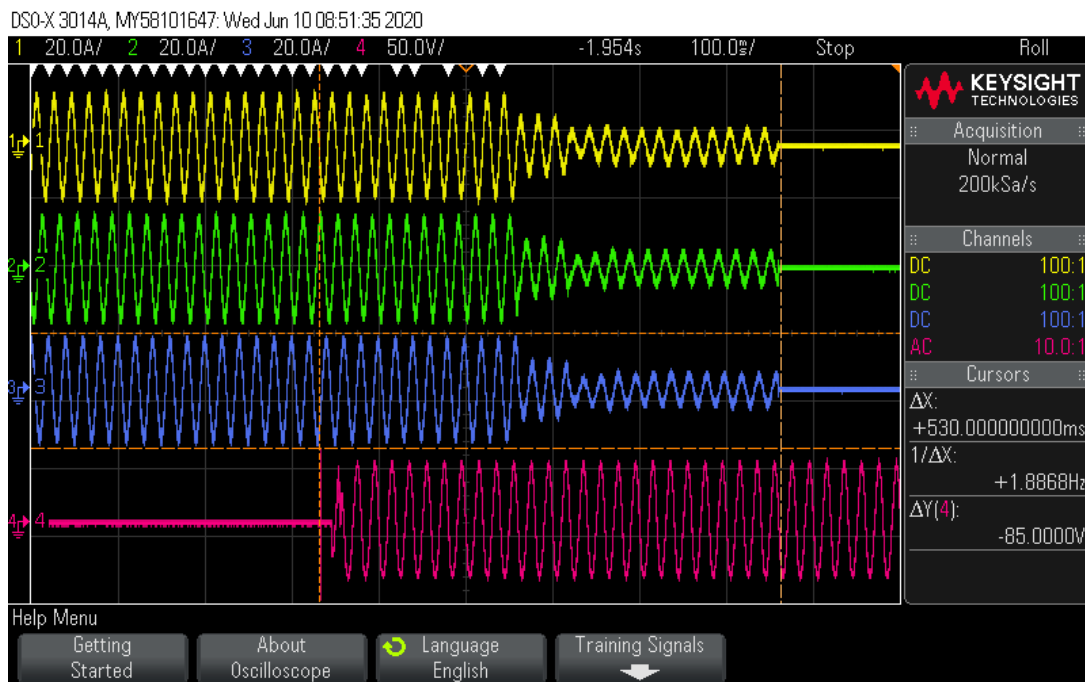

Attention:

For Thailand only picture with all three current phases L1, L2 and L3 are accepted

All relays are direct coupled and open directly by receiving the islanding signal from the controller.

Note:

CH1,CH2,CH3: Current of EUT(20A/div); CH4: trip signal

6.1 Islanding protection according Table 7 – Load imbalance (reactive load) for test condition C (EUT output = 25 % – 33 %) 3.9, 12.4 Anti-Islanding (PEA:2016)									P
Test conditions		Frequency: 50+/-0,1Hz U _N =220+/-3Vac Distortion factor of chokes < 2% Quality =1							
Disconnection limit		1s							
No	P _{EUT} ¹⁾ (% of EUT rating)	Reactive load (% of Q _L in 6.1.d) 1)	P _{AC} ²⁾ (% of nominal)	Q _{AC} ³⁾ (% of nominal)	Run on Time (ms)	P _{EUT} (W per phase)	Actual Q _f	V _{DC} (V)	Remarks ⁴⁾
1	33	33	0	-5	432	1100	0,975	305	Test C at IB
2	33	33	0	-4	468	1100	0,980	305	Test C at IB
3	33	33	0	-3	484	1100	0,985	305	Test C at IB
4	33	33	0	-2	430	1100	0,990	305	Test C at IB
5	33	33	0	-1	430	1100	0,995	305	Test C at IB
6	33	33	0	0	536	1100	1,000	305	Test C at BL
7	33	33	0	1	414	1100	1,005	305	Test C at IB
8	33	33	0	2	458	1100	1,010	305	Test C at IB
9	33	33	0	3	394	1100	1,015	305	Test C at IB
10	33	33	0	4	520	1100	1,020	305	Test C at IB
11	33	33	0	5	424	1100	1,025	305	Test C at IB
Parameter at 0% per phase			L= 152,39mH		R= 47,87Ω		C= 66,49μF		
IAC fundamental current(A)			102 mA						
<p>Note: RLC is adjusted to min. +/-1% of the inverter rated output power 1) P_{EUT}: EUT output power 2) P_{AC}: Real power flow at S1 in Figure 1. Positive means power from EUT to utility. Nominal is the 0 % test condition value. 3) Q_{AC}: Reactive power flow at S1 in Figure 1. Positive means power from EUT to utility. Nominal is the 0 % test condition value. 4) BL: Balance condition, IB: Imbalance condition. Condition C: EUT output power P_{EUT} = 25 % – 33 %⁵⁾ of maximum EUT input voltage⁶⁾ = <10 % of rated input voltage range 5) Or minimum allowable EUT output level if greater than 33 %. 6) Based on EUT rated input operating range. For example, If range is between X volts and Y volts, 10 % of range =X + 0,1 × (Y – X). Y shall not exceed 0,8 × EUT maximum system voltage (i.e., maximum allowable array open circuit voltage). In any case, the EUT should not be operated outside of its allowable input voltage range.</p>									

Disconnection at P_{AC} 0% and Q_{AC} +0% reactive load No. 6

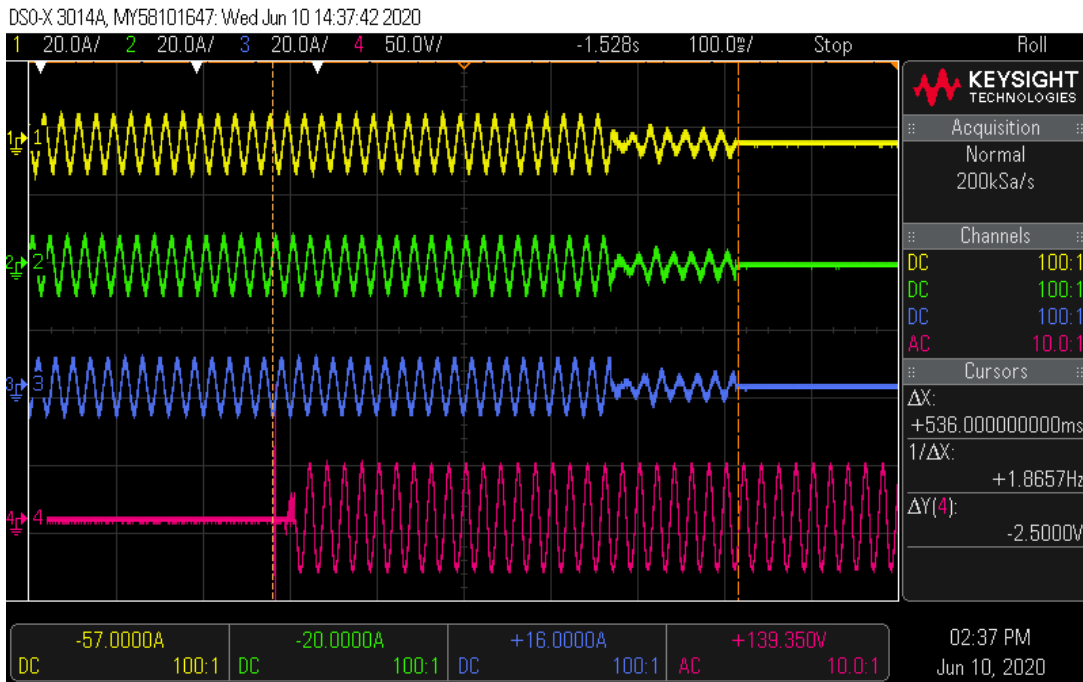

Attention:

For Thailand only picture with all three current phases L1, L2 and L3 are accepted

All relays are direct coupled and open directly by receiving the islanding signal from the controller.

Note:

CH1,CH2,CH3: Current of EUT(20A/div); CH4: trip signal



PEA:2016 additional test						P
3.4 Reactive power control(PEA:2016)						P
Test conditions:		Output: 220 Vac,50Hz				
P (setting)	P(kW)ind	P(kW)cap	Q(kVar)ind, max	Q(kVar)cap, max	PFind, max	PFcap, max
0%	0,454	0,455	0,237	0,172	0,8380	0,9332
10%	0,968	0,970	0,428	0,444	0,8869	0,9091
20%	1,987	1,985	-0,992	0,963	0,8945	0,8997
30%	3,002	3,003	-1,459	1,423	0,8994	0,9037
40%	4,020	4,018	-1,929	1,940	0,9016	0,9005
50%	5,030	5,030	-2,395	2,456	0,9029	0,8986
60%	6,038	6,039	-2,860	2,970	0,9037	0,8974
70%	7,043	7,046	-3,324	3,483	0,9043	0,8965
80%	8,050	8,052	-3,788	3,996	0,9048	0,8958
90%	9,054	9,055	-4,253	4,508	0,9051	0,8952
100%	10,047	10,032	-4,713	5,004	0,9053	0,8949
Note:						

PEA:2016 additional test					P
3.4.1, 8.1.2 1) A fixed displacement factor $\cos\phi$					P
Test conditions:		Output: 220 Vac, 50Hz			
P (setting)	PF (setting)	P(kW)	Q(kVar)	PF	
0%	0,90 lagging	0,454	0,237	0,8380	
10%	0,90 lagging	0,968	0,428	0,8869	
20%	0,90 lagging	1,987	-0,992	0,8945	
30%	0,90 lagging	3,002	-1,459	0,8994	
40%	0,90 lagging	4,020	-1,929	0,9016	
50%	0,90 lagging	5,030	-2,395	0,9029	
60%	0,90 lagging	6,038	-2,860	0,9037	
70%	0,90 lagging	7,043	-3,324	0,9043	
80%	0,90 lagging	8,050	-3,788	0,9048	
90%	0,90 lagging	9,054	-4,253	0,9051	
100%	0,90 lagging	10,047	-4,713	0,9053	
P (setting)	PF (setting)	P(kW)	Q(kVar)	PF	
0%	0,90 leading	0,455	0,172	0,9332	
10%	0,90 leading	0,970	0,444	0,9091	
20%	0,90 leading	1,985	0,963	0,8997	
30%	0,90 leading	3,003	1,423	0,9037	
40%	0,90 leading	4,018	1,940	0,9005	
50%	0,90 leading	5,030	2,456	0,8986	
60%	0,90 leading	6,039	2,970	0,8974	
70%	0,90 leading	7,046	3,483	0,8965	
80%	0,90 leading	8,052	3,996	0,8958	
90%	0,90 leading	9,055	4,508	0,8952	
100%	0,90 leading	10,032	5,004	0,8949	
P (setting)	PF (setting)	P(kW)	Q(kVar)	PF	
0%	1,00	0,449	0,124	0,9547	
10%	1,00	0,972	0,108	0,9935	
20%	1,00	1,992	0,090	0,9989	
30%	1,00	3,010	0,070	0,9997	

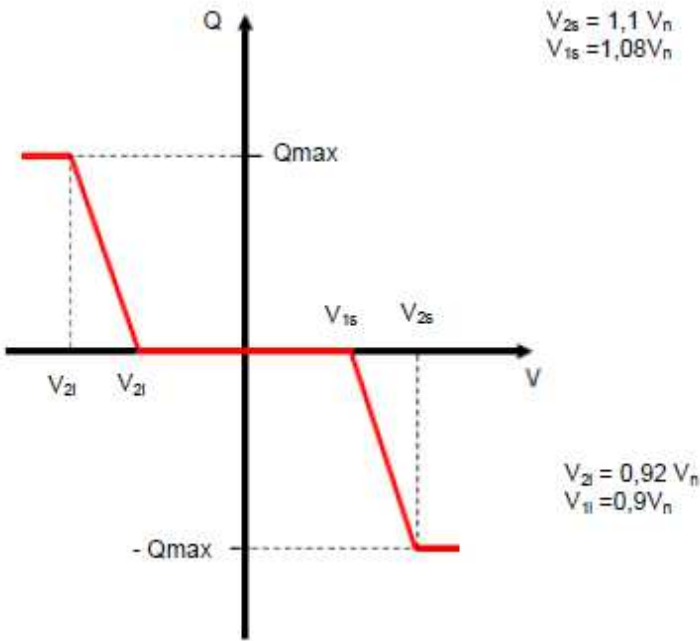

40%	1,00	4,026	0,066	0,9999
50%	1,00	5,039	0,069	0,9999
60%	1,00	6,053	0,078	0,9999
70%	1,00	7,064	0,086	0,9999
80%	1,00	8,073	0,099	0,9999
90%	1,00	9,081	0,114	0,9999
100%	1,00	10,078	0,131	0,9999
Note:				

<p>PEA:2016 additional test</p>	<p>P</p>
<p>3.4.2, 8.1.2 2) A variable reactive power depending on the voltage Q(U) (PEA:2016) (Power generation system is greater than 500kW)</p>	<p>P</p>
<p>The purpose of the test is to ensure that the converter complies with the methods for automatically supplying reactive power according to the standard characteristic curve Q(U) indicated in 1.5.</p> <p>Activation must be at the Distributor's request, when the Operating Regulations are issued. The Distributor shall also specify the values of the parameters that uniquely characterise the curve, i.e.: V1i, V2i, V1s and V1s as well as the lock-in value of active power (default value $P = 0,2 P_n$).</p> <p>The parameters V1i, V2i, V1s and V1s should be set in the range between 0,9 and 1,1 with 0,01 V_n steps. In order to facilitate execution of the type tests, the characterising parameters are conventionally set as follows: $V1s = 1,08 V_n$; $V2s = 1,1 V_n$ $V1i = 0,92 V_n$; $V2i = 0,9 V_n$ and the active power lock-in value (default value $P = 0,2 P_n$).</p> <div style="text-align: center;">  <p>The graph shows a characteristic curve of reactive power Q versus voltage V. The vertical axis is labeled Q and has markers for Qmax and -Qmax. The horizontal axis is labeled V and has markers for V2i, V2s, V1s, and V1i. The curve starts at a constant positive Qmax for voltages up to V2i. Between V2i and V2s, the curve decreases linearly to zero. Between V2s and V1s, the curve remains at zero. Between V1s and V1i, the curve decreases linearly to a constant negative value -Qmax. For voltages above V1i, the curve remains constant at -Qmax. The following parameter values are specified:</p> <ul style="list-style-type: none"> $V_{2s} = 1,1 V_n$ $V_{1s} = 1,08 V_n$ $V_{2i} = 0,92 V_n$ $V_{1i} = 0,9 V_n$ </div>	

Qmin reactive power in accordance to standard characteristic curve Q=f(V)								
P(setting)	Vac [V] Set point	P[KW] measured	Vac [V]measured			Q [kVar] measured	Q [kVar] expected	ΔQ [kVar]
			L1	L2	L3			
< 20%	1,07Vn	1,470	235,00	235,00	235,00	0,115	≈0(<±2,5%Pn)	0,115
< 20%	1,09Vn	1,473	239,98	239,98	239,98	0,115	≈0(<±2,5%Pn)	0,115
< 20%-30%	1,09Vn	2,469	240,00	240,00	240,00	-2,358	-2,422	0,064
40%	1,09Vn	3,999	240,00	240,00	240,00	-2,420	-2,422	0,002
50%	1,09Vn	5,024	240,00	240,00	240,00	-2,403	-2,422	0,019
60%	1,09Vn	6,030	240,00	240,00	240,00	-2,425	-2,422	-0,003
70%	1,09Vn	7,042	240,00	240,00	240,00	-2,454	-2,422	-0,032
80%	1,09Vn	8,051	240,00	240,00	240,00	-2,471	-2,422	-0,049
90%	1,09Vn	9,075	240,00	240,00	240,00	-2,401	-2,422	0,021
100%	1,09Vn	10,100	240,00	240,00	240,00	-2,436	-2,422	-0,014
100%	1,10Vn	10,100	242,00	242,00	242,00	-4,847	-4,843	-0,004
100%-10%	1,10Vn	0,894	242,00	242,00	242,00	-4,840	-4,843	0,003
10%→ ≤5%	1,10Vn	0,347	242,00	242,00	242,00	0,076	≈0(<±2,5%Pn)	0,076
Qmax reactive power in accordance to standard characteristic curve Q=f(V)								
P(setting)	Vac [V] Set point	P[KW] measured	Vac [V]measured			Q [kVar] measured	Q [kVar] expected	ΔQ [kVar]
			L1	L2	L3			
< 20%	0,93Vn	1,464	204,62	204,63	204,62	0,085	≈0(<±2,5%Pn)	0,085
< 20%	0,91Vn	1,465	200,22	200,23	200,23	0,080	≈0(<±2,5%Pn)	0,080
< 20%-30%	0,91Vn	2,478	200,29	200,29	200,31	2,464	2,422	0,042
40%	0,91Vn	4,002	200,38	200,39	200,35	2,438	2,422	0,016
50%	0,91Vn	5,012	200,00	200,00	200,00	2,426	2,422	0,004
60%	0,91Vn	6,021	200,41	200,38	200,36	2,475	2,422	0,053
70%	0,91Vn	7,016	200,00	200,00	200,00	2,443	2,422	0,021
80%	0,91Vn	8,031	200,51	200,48	200,49	2,409	2,422	-0,013
90%	0,91Vn	9,034	200,57	200,55	200,53	2,371	2,422	-0,051
100%	0,91Vn	10,033	200,48	200,47	200,48	2,471	2,422	0,049
100%	0,90Vn	10,010	198,32	198,30	198,30	4,804	4,843	-0,039
100%-10%	0,90Vn	0,906	198,00	197,98	198,00	4,844	4,843	0,001
10%→ ≤5%	0,90Vn	0,349	197,94	197,96	197,96	0,086	≈0(<±2,5%Pn)	0,086
Note: The lock-in value is adjustable between V _n and 1.1V _n and the lock-out value between V _n and 0.9V _n in 0,01V _n steps.								

Graph: Lock-in at 1,08Vn

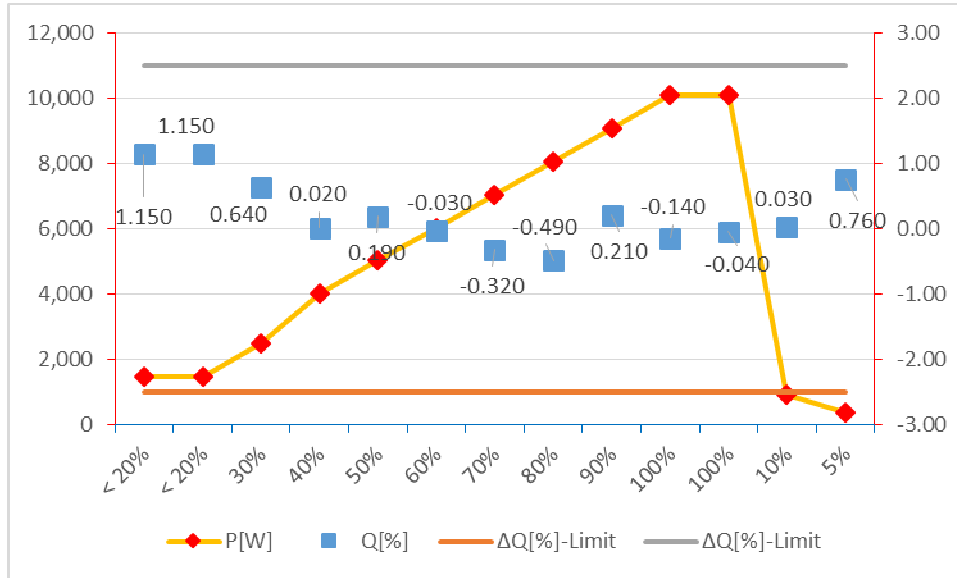

Graph: Lock-in at 1,08Vn

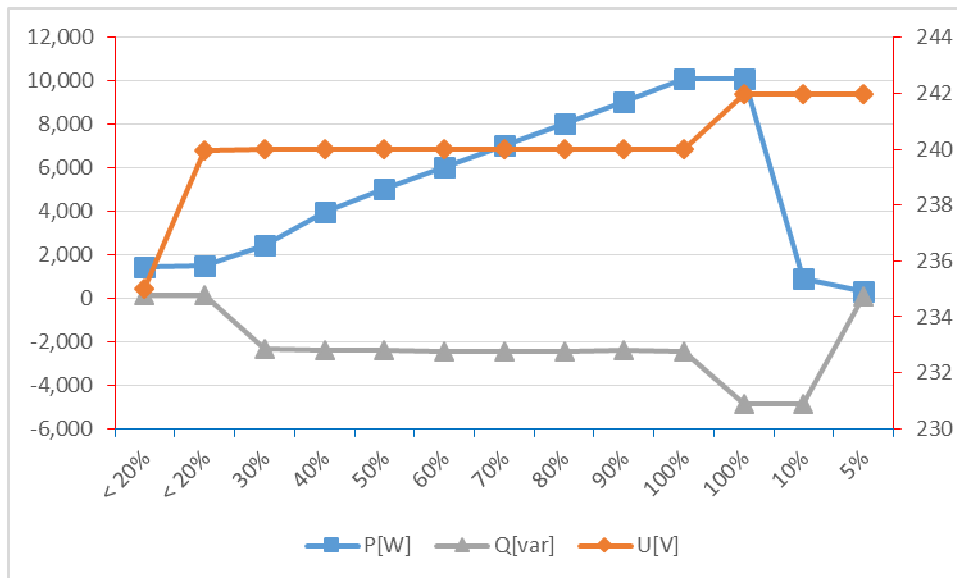

Graph: Lock-in at 0,92Vn

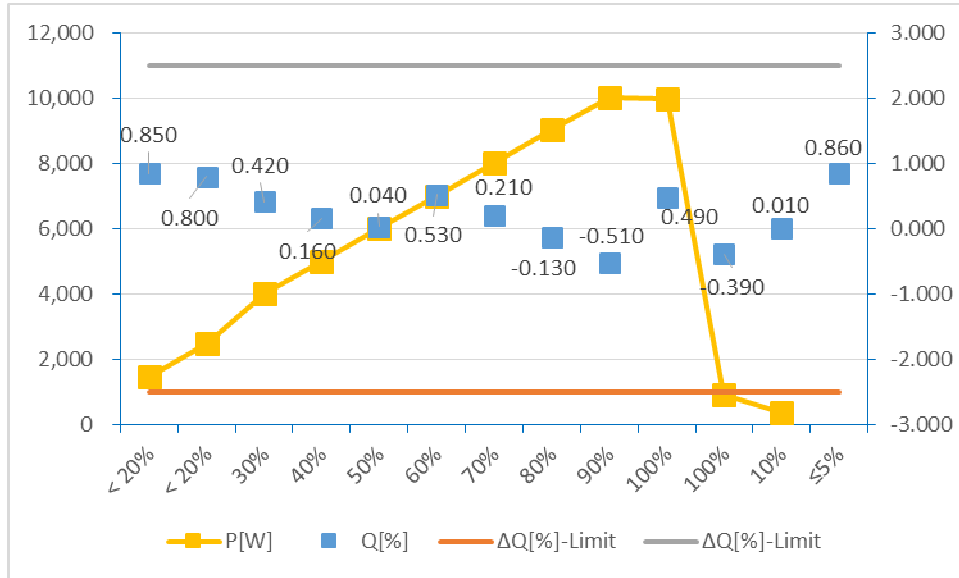

Graph: Lock-in at 0,92Vn

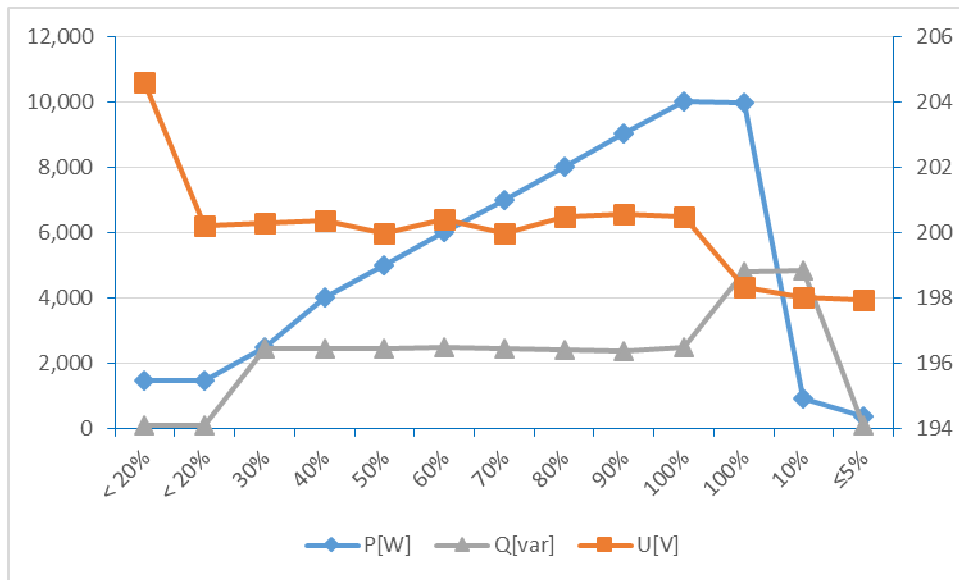

PEA:2016 additional test			P
3.5, 12.1 Active power control (PEA:2016)			P
Setpoint in power bin [%]	P_{setpoint} [kW]	P₆₀ [kW]	Decrease time (s)
100%	10,00	10,08	7
90%	9,00	9,12	7
80%	8,00	8,12	7
70%	7,00	7,11	8
60%	6,00	6,10	7
50%	5,00	5,09	8
40%	4,00	4,08	7
30%	3,00	3,08	7
20%	2,00	2,07	8
10%	1,00	1,06	7
0%	0,00	0,56	6

Graph of the setting accuracy

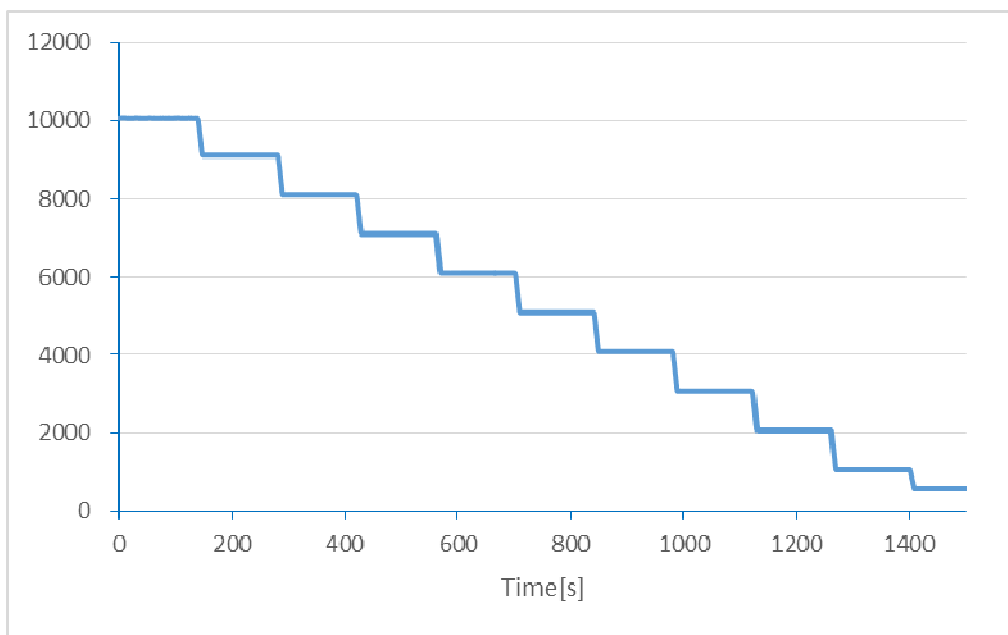

Note:



PEA:2016 additional test		P
3.6, 12.2 Low voltage fault Ride through capability (PEA:2016) (Power generation system is greater than 500kW)		P
Test List	V(V/V _n)	Duration time (Sec)
Test P>0,9P _n *		
Three-phase faults	0,7-0,8V _n (166,4V)	1,019
	0,3-0,5V _n (100,4V)	0,161
	0-0,05V _n (10,5V)	0,161
Phase to phase faults	0,7-0,8V _n (165,0V)	1,014
	0,3-0,5V _n (97,9V)	0,160
	0-0,05V _n (9,8V)	0,161
Single phase to ground faults	0,7-0,8V _n (165,0V)	1,017
	0,3-0,5V _n (100,4V)	0,160
	0-0,05V _n (9,8V)	0,161
Test P=0,3P _n		
Three-phase faults	0,7-0,8V _n (165,0V)	1,016
	0,3-0,5V _n (97,9V)	0,161
	0-0,049V _n (10,6V)	0,161
Phase to phase faults	0,7-0,8V _n (165,0V)	1,014
	0,3-0,5V _n (97,9V)	0,161
	0-0,049V _n (9,8V)	0,161
Single phase to ground faults	0,7-0,8V _n (166,4V)	1,017
	0,3-0,5V _n (97,9V)	0,161
	0-0,049V _n (9,8V)	0,160
Test P=0,1 P _n		
Three-phase faults	0,7-0,8V _n (166,1V)	1,013
	0,3-0,5V _n (100,4V)	0,161
	0-0,049V _n (10,5V)	0,161
Phase to phase faults	0,7-0,8V _n (164,0V)	1,019
	0,3-0,5V _n (100,4V)	0,161
	0-0,049V _n (9,8V)	0,161

Single phase to ground faults	0,7-0,8V _n (166,4V)	1,016
	0,3-0,5V _n (100,4V)	0,161
	0-0,049V _n (9,8V)	0,161

Note:

The PGS must not disconnected from grid while the PCC voltage dip period less than below curve limit.

- a) install and connect the PGS and recommendation of the technical requirements of the equipment manufacturer .
- b) Check all parameters of power supply in normal conditions, the operation of power system equipment .
- c) testing by simulation the voltage . (I try to short-circuit in the power network) in the electricity network to balance the pressure between 70-80%V_n , 30-50%V_n, and less than 5 percent of the normal operating pressure .
- d) Record the maximum time power system can still connect to the electricity network as shown on above table.

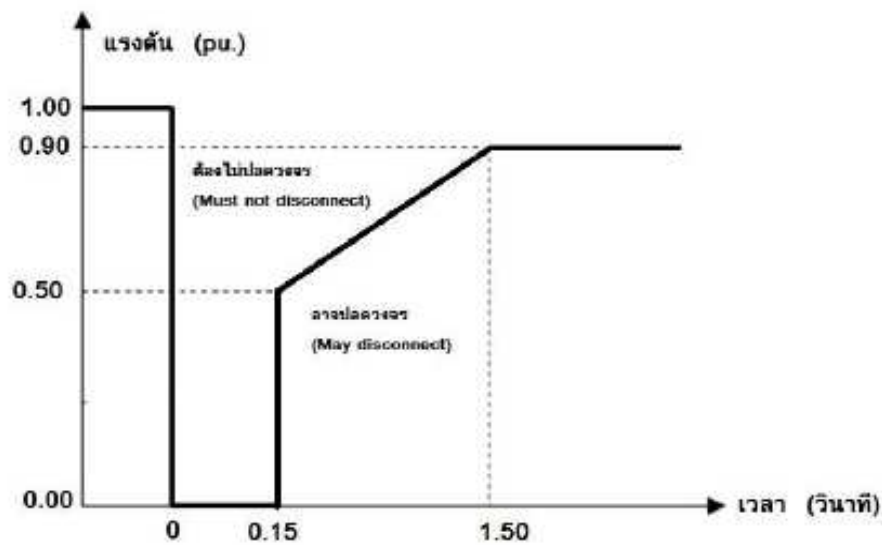

Three-phase faults graph at 100%P_n: 0,7-0,8U_n

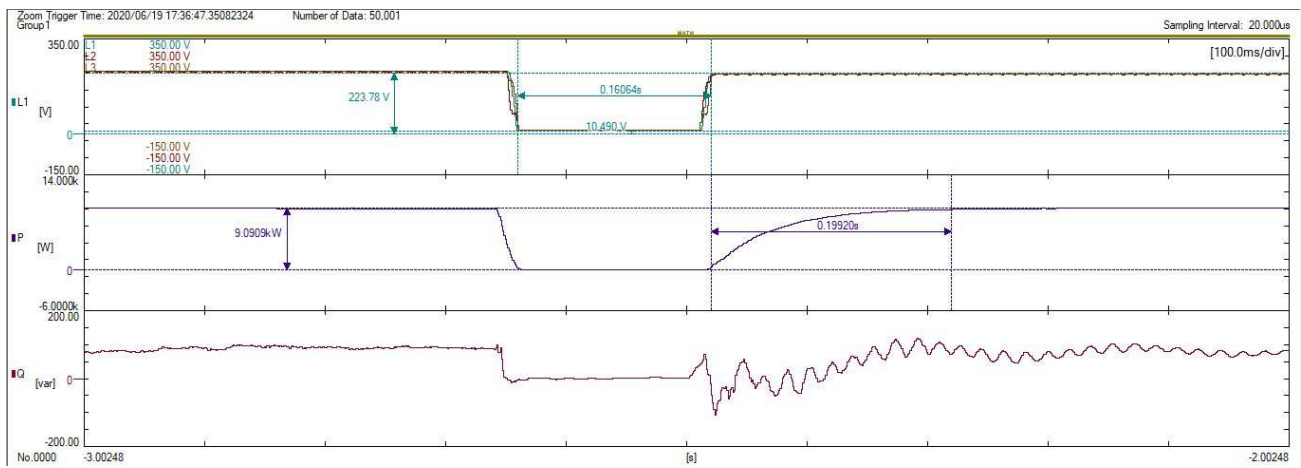

Three-phase faults graph at 100%P_n: 0,3-0,5U_n

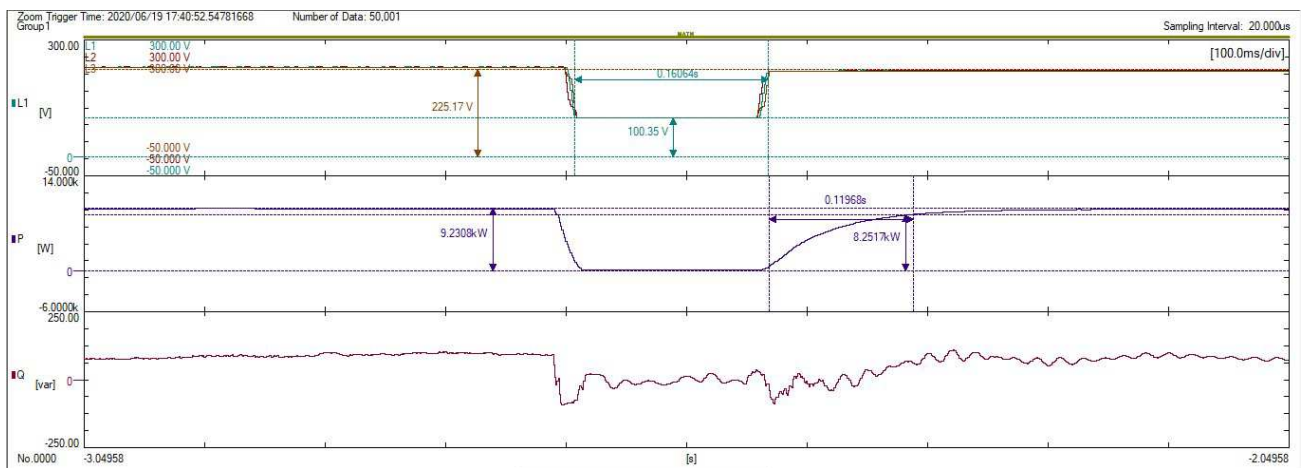

Three-phase faults graph at 100%P_n: 0,00Un-0,049Un

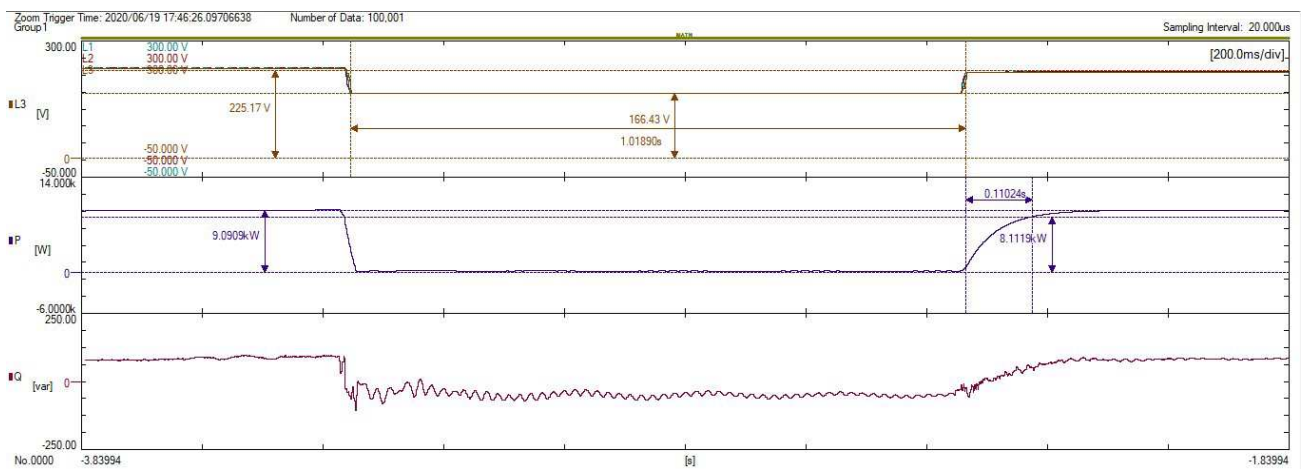

L1 phase-L2 phase faults 0,7-0,8Vn-Voltage graph at 100%P_n

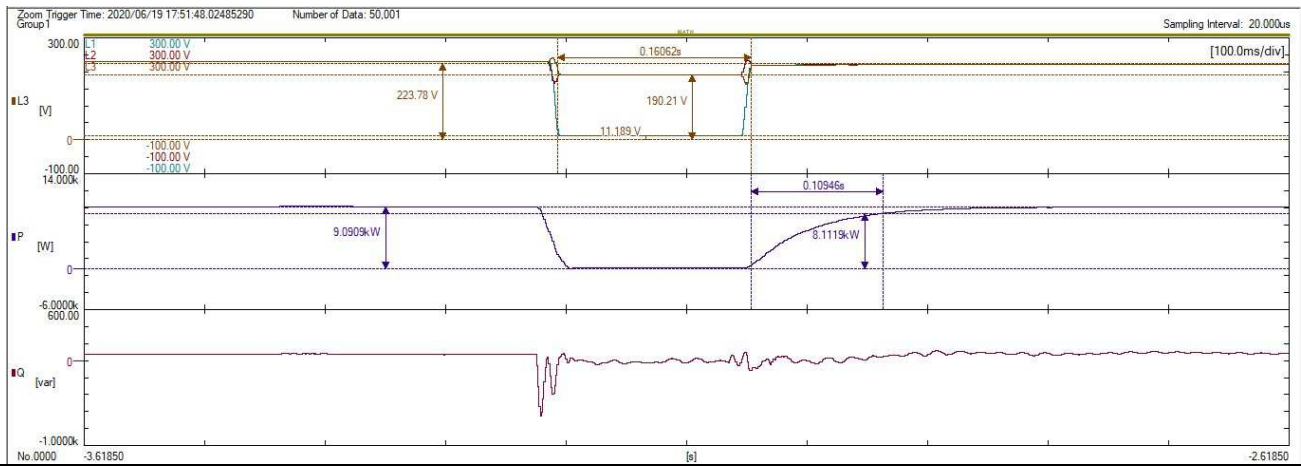

L1 phase-L2 phase faults 0,3-0,5Vn-Voltage graph at 100%P_n

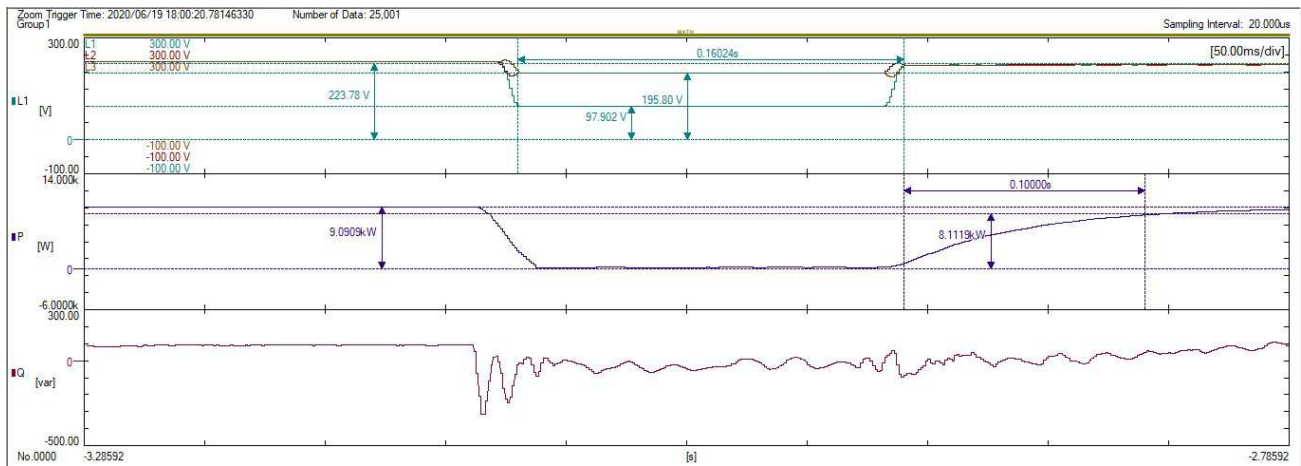

L1 phase-L2 phase faults 0-0,049Vn-Voltage graph at 100%P_n

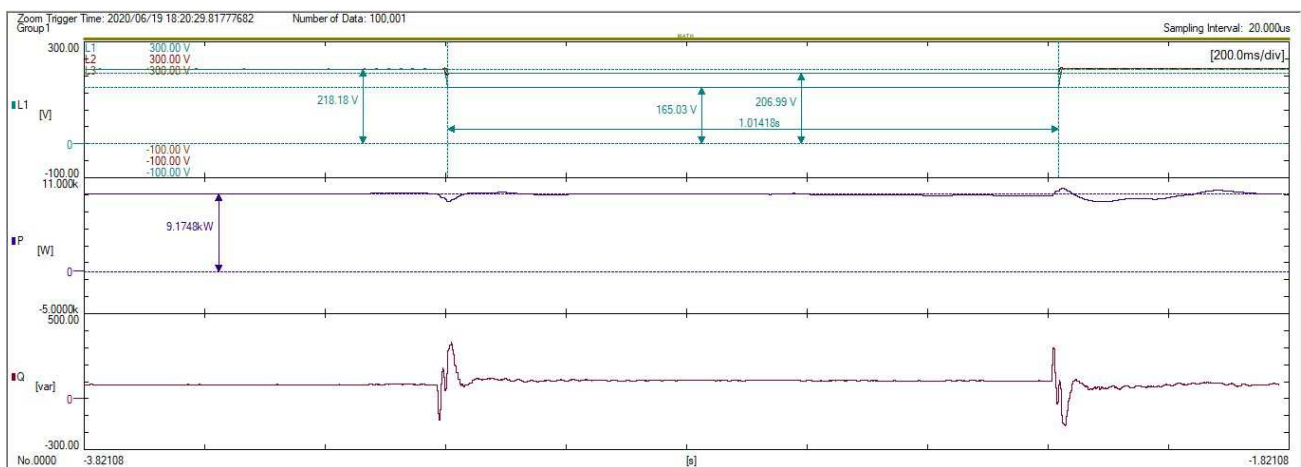

L1 phase-ground faults 0,7-0,8Vn-Voltage graph at 100%P_n

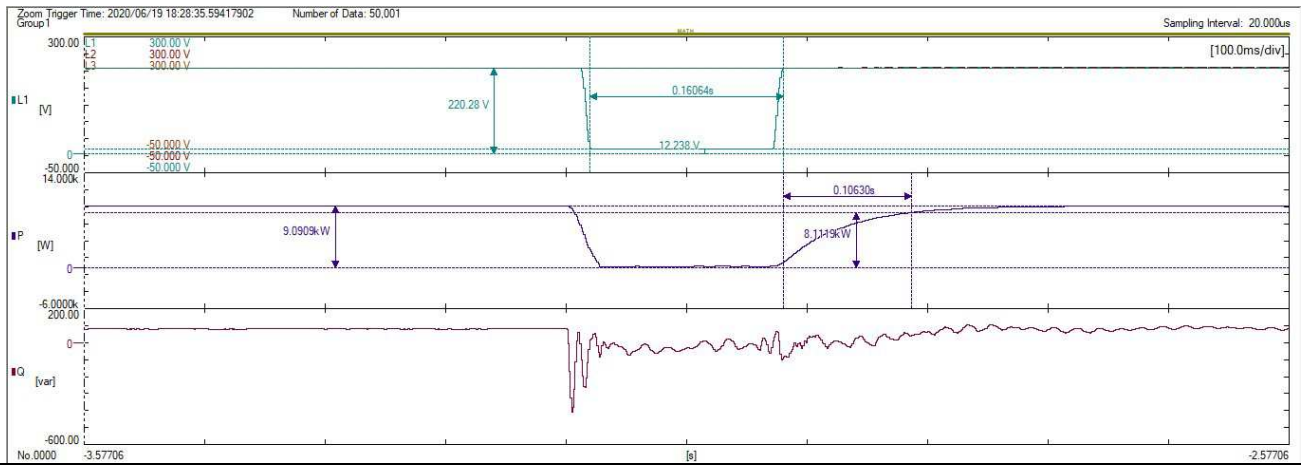

L1 phase-ground faults 0,3-0,5Vn-Voltage graph at 100%P_n

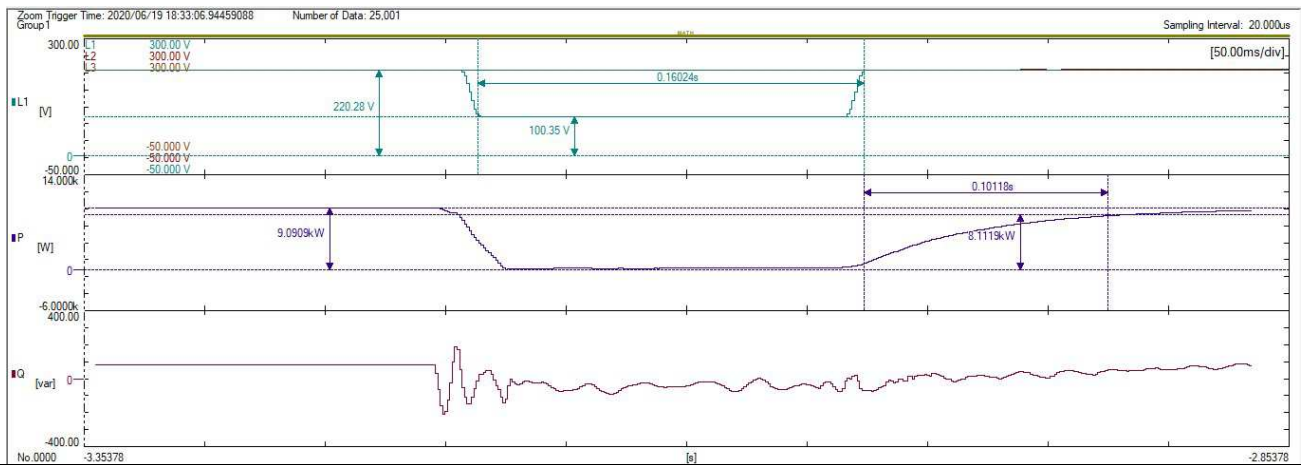

L1 phase-ground faults 0-0,049Vn-Voltage graph at 100%P_n

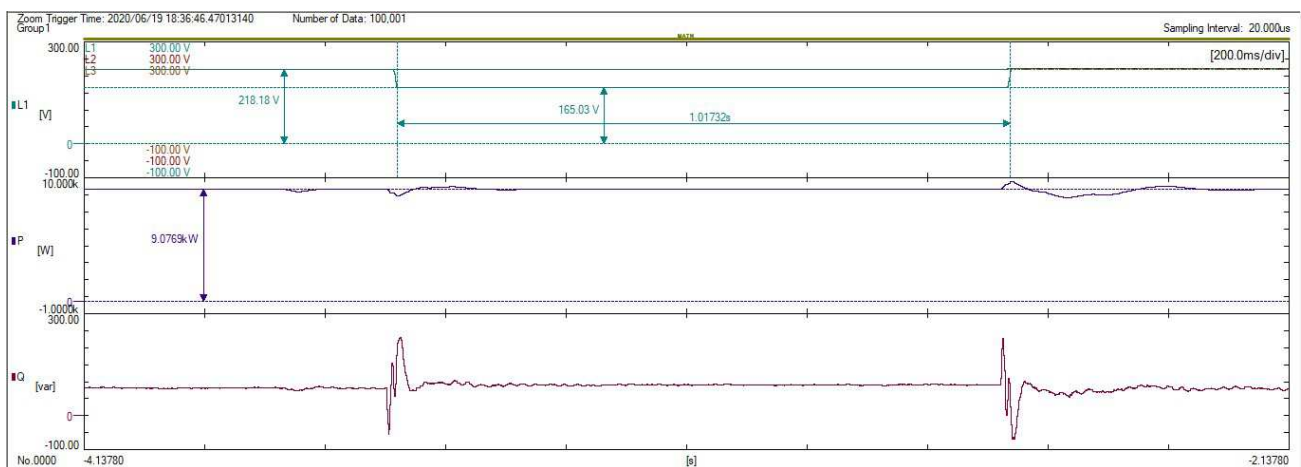

Three-phase faults graph at 30%P_n: 0.7-0.8U_n

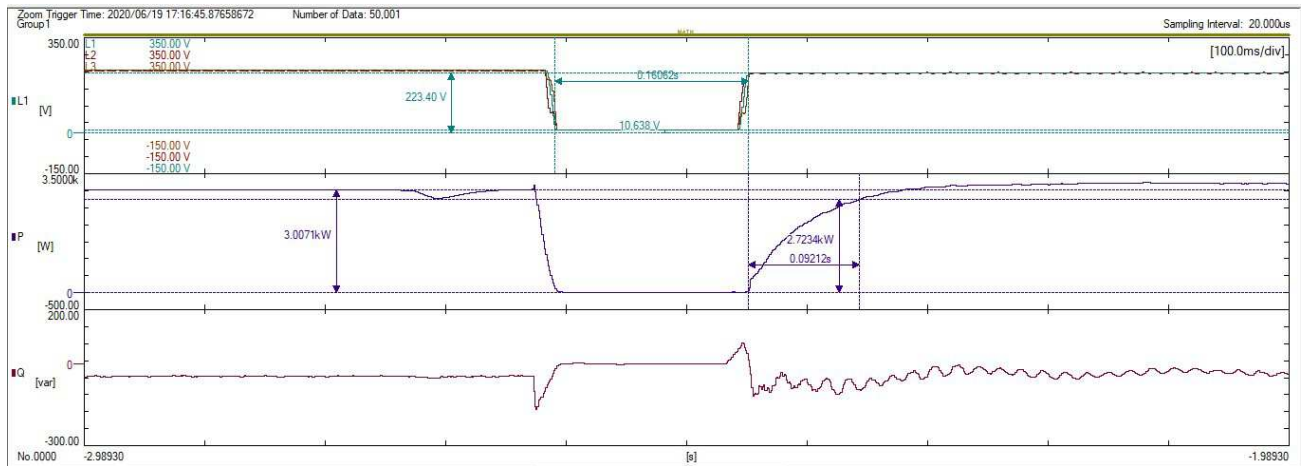

Three-phase faults graph at 30%P_n: 0.3-0.5U_n

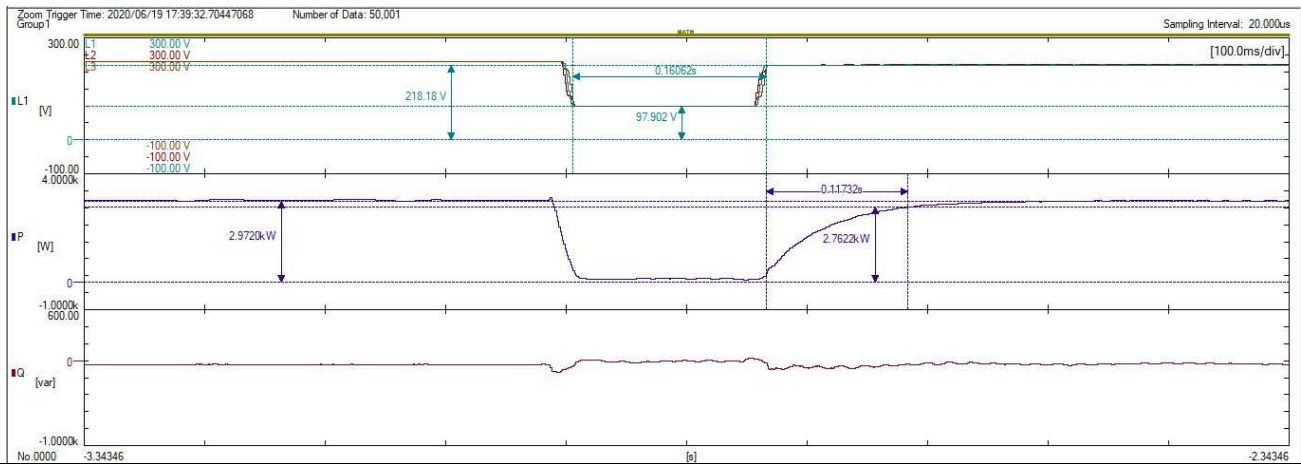

Three-phase faults graph at 30%P_n: 0-0.049U_n

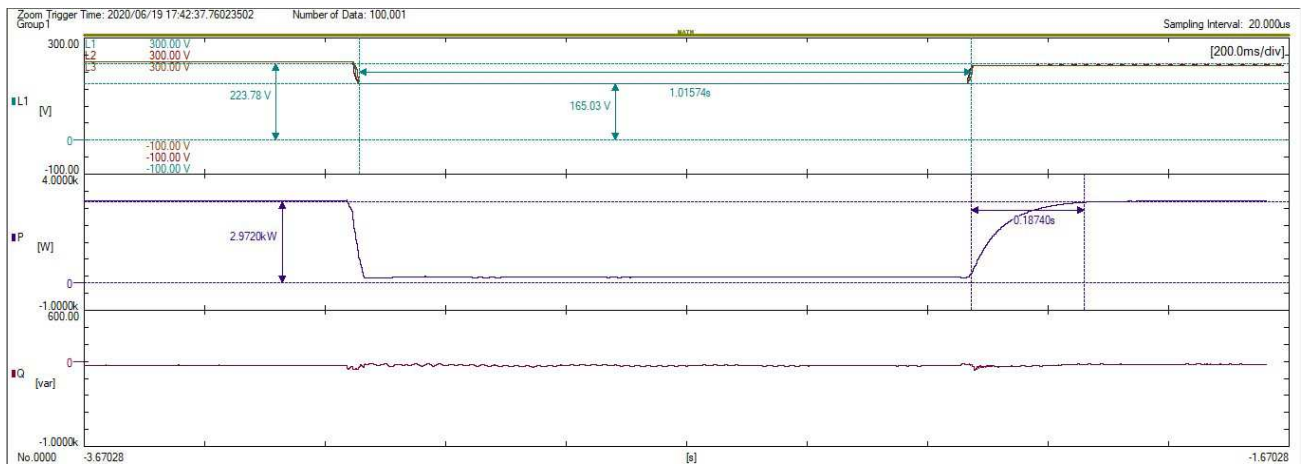

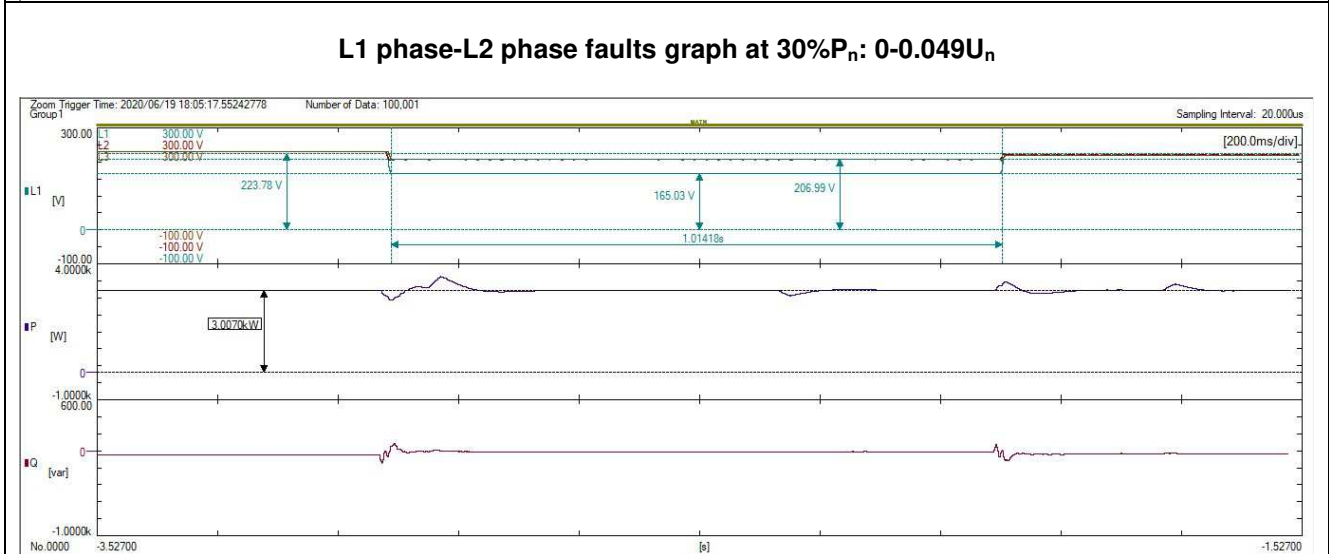
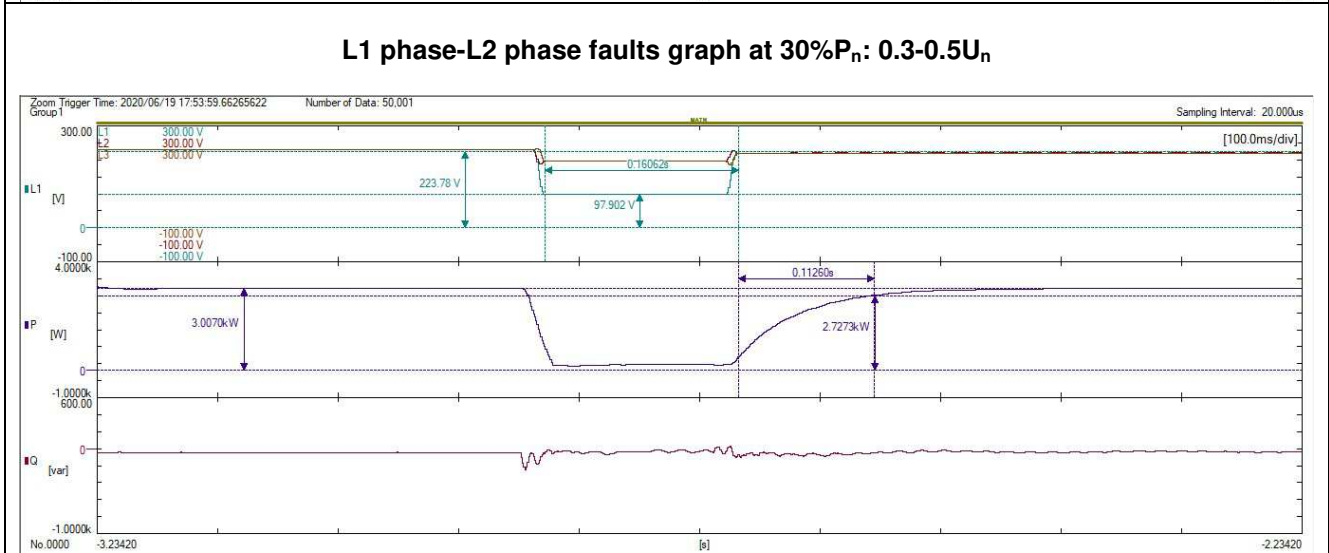
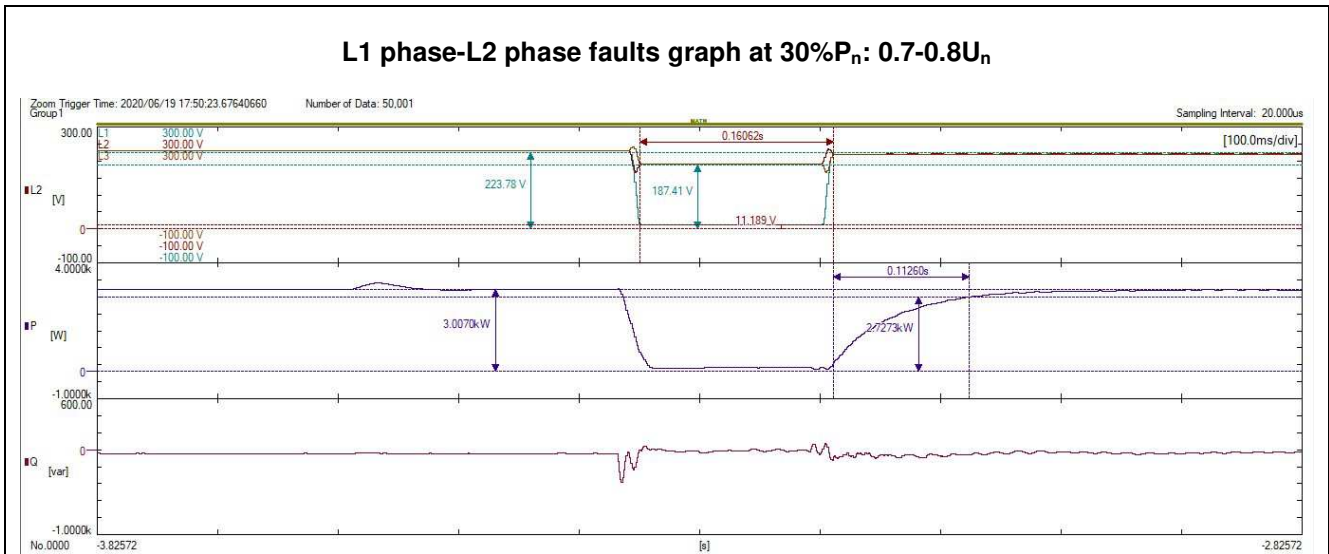

L1 phase-ground faults graph at 30%P_n: 0.7-0.8U_n

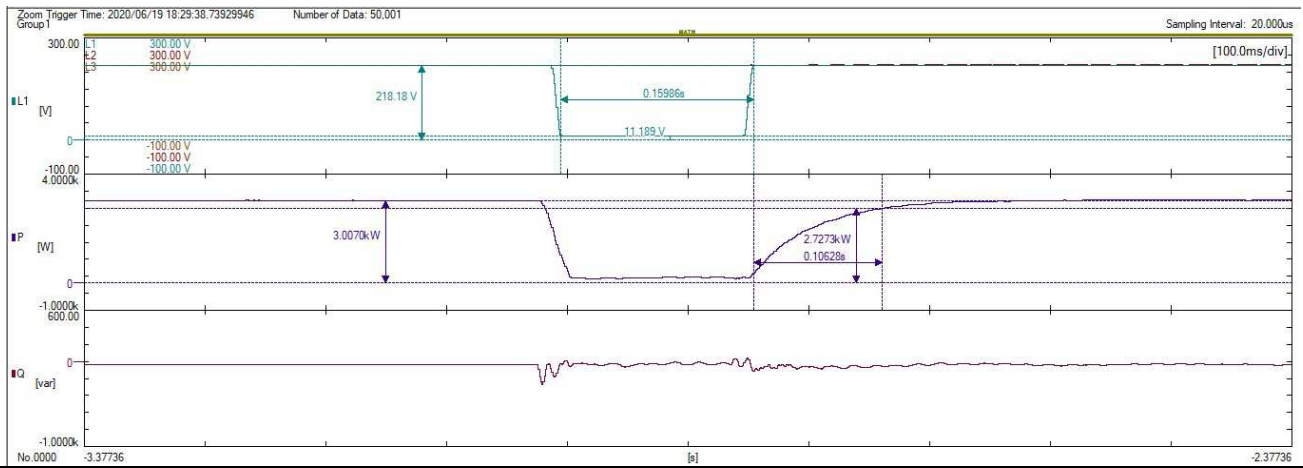

L1 phase-ground faults graph at 30%P_n: 0.3-0.5U_n

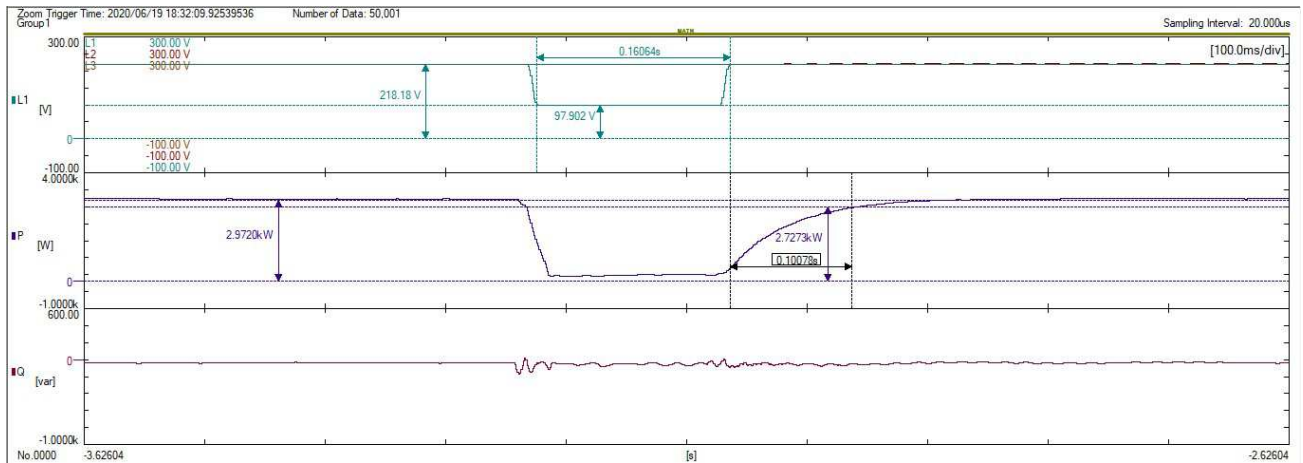

L1 phase-ground graph at 30%P_n: 0-0.049U_n

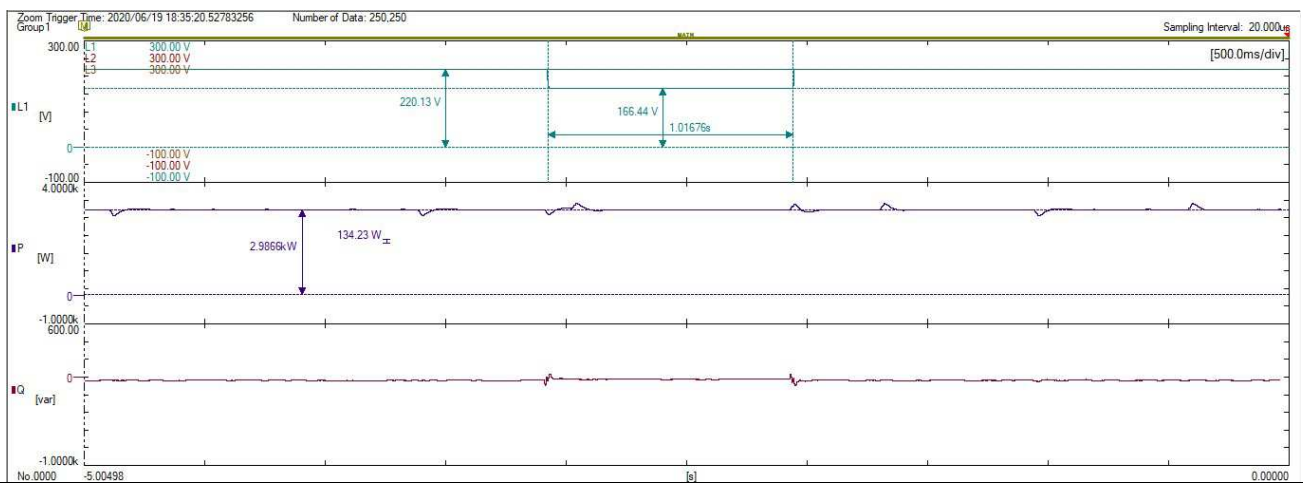

Three-phase faults graph at 10%P_n: 0.7-0.8U_n

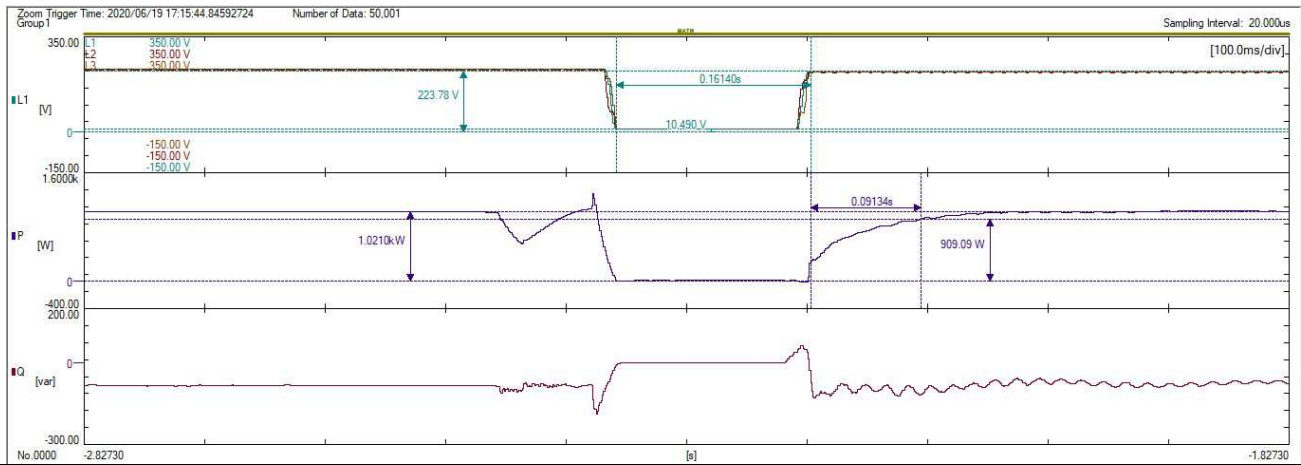

Three-phase faults graph at 10%P_n: 0.3-0.5U_n

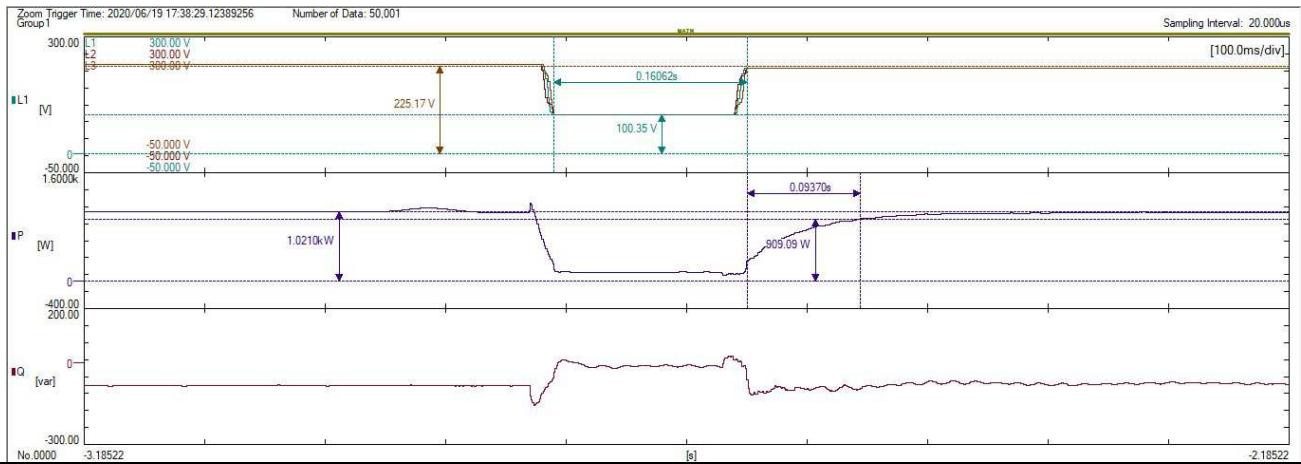

Three-phase faults graph at 10%P_n: 0-0.049U_n

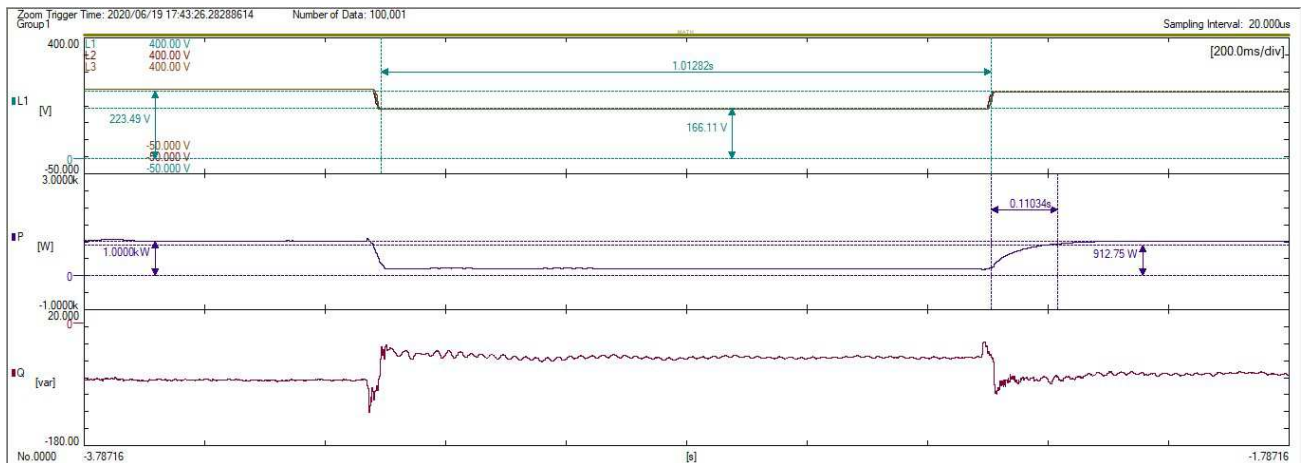

L1 phase-L2 phase graph at 10%P_n: 0.7-0.8U_n

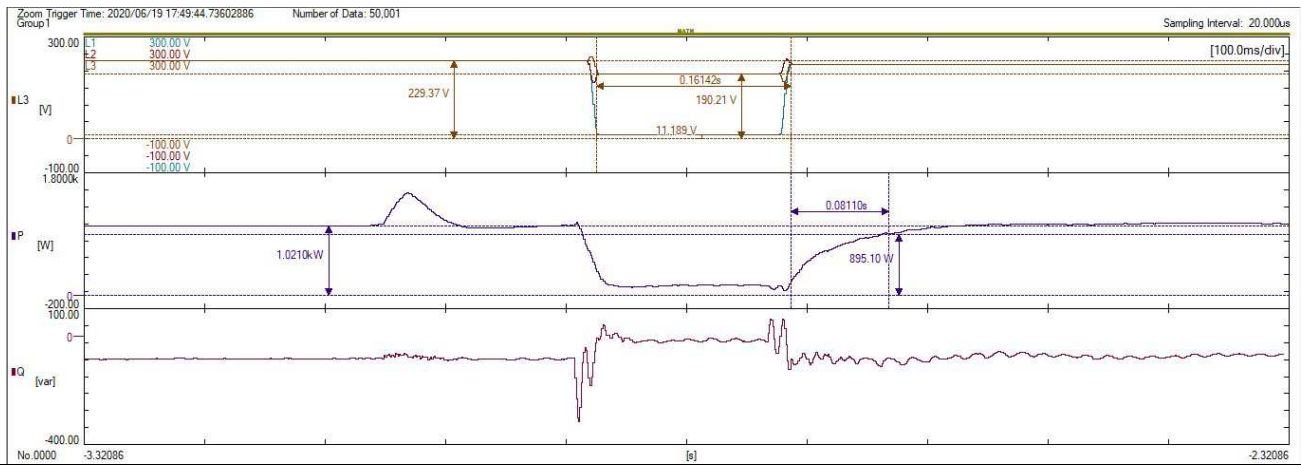

L1 phase-L2 phase faults graph at 10%P_n: 0.3-0.5U_n

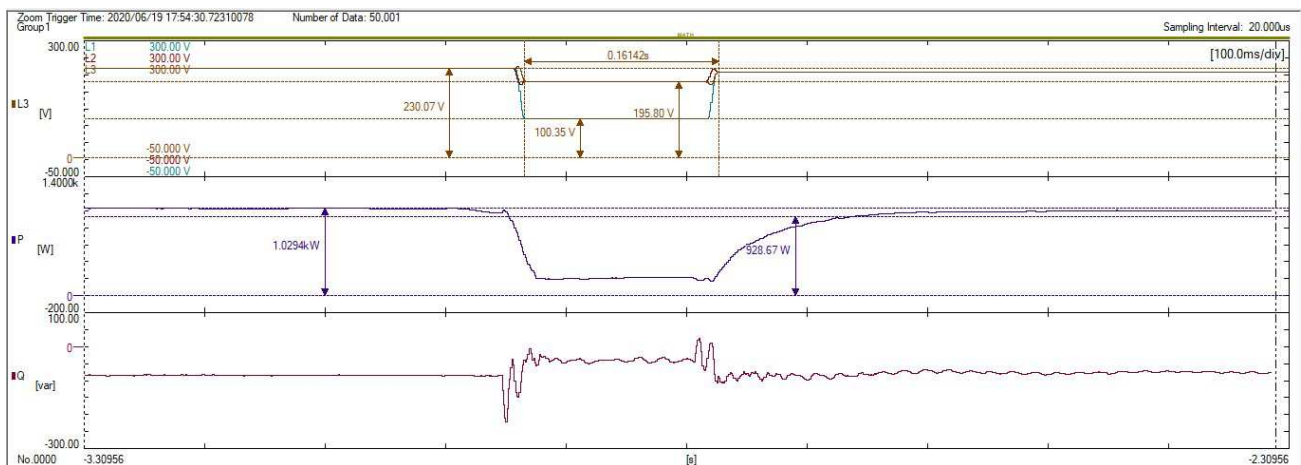

L1 phase-L2 phase faults graph at 10%P_n: 0-0.049U_n

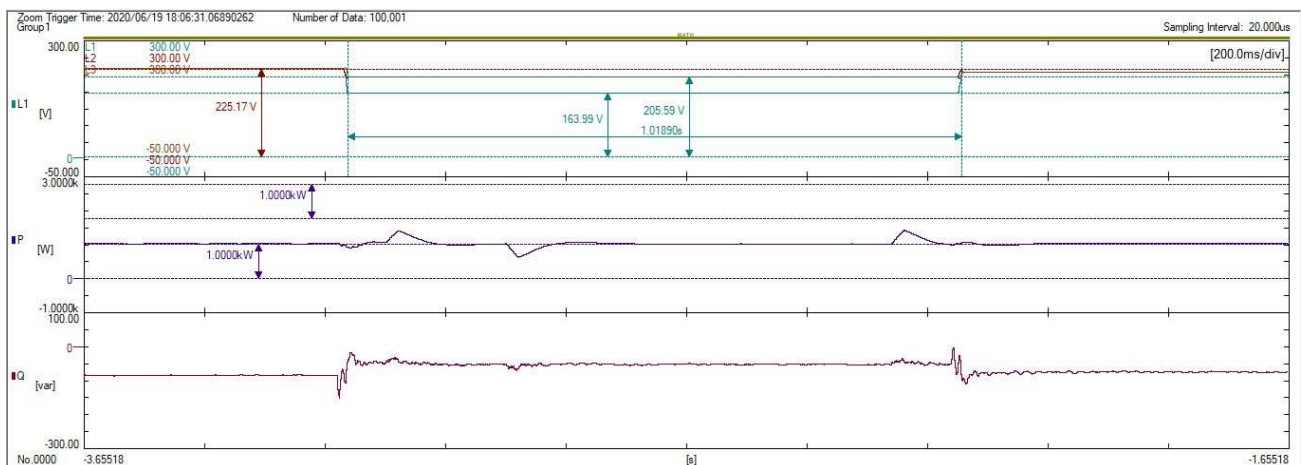

L1 phase-ground faults graph at 10%P_n: 0.7-0.8U_n

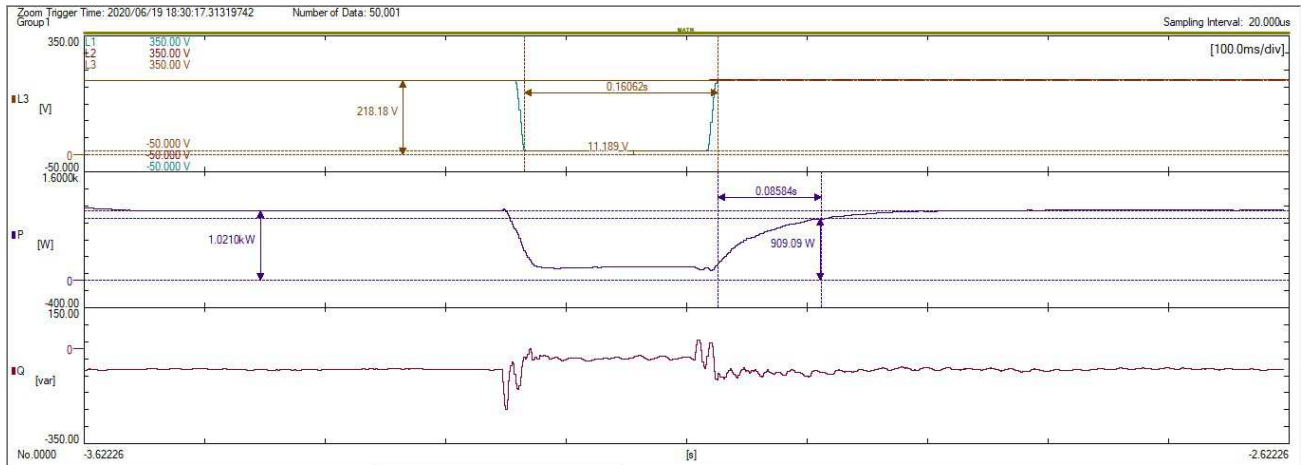

L1 phase-ground faults graph at 10%P_n: 0.3-0.5U_n

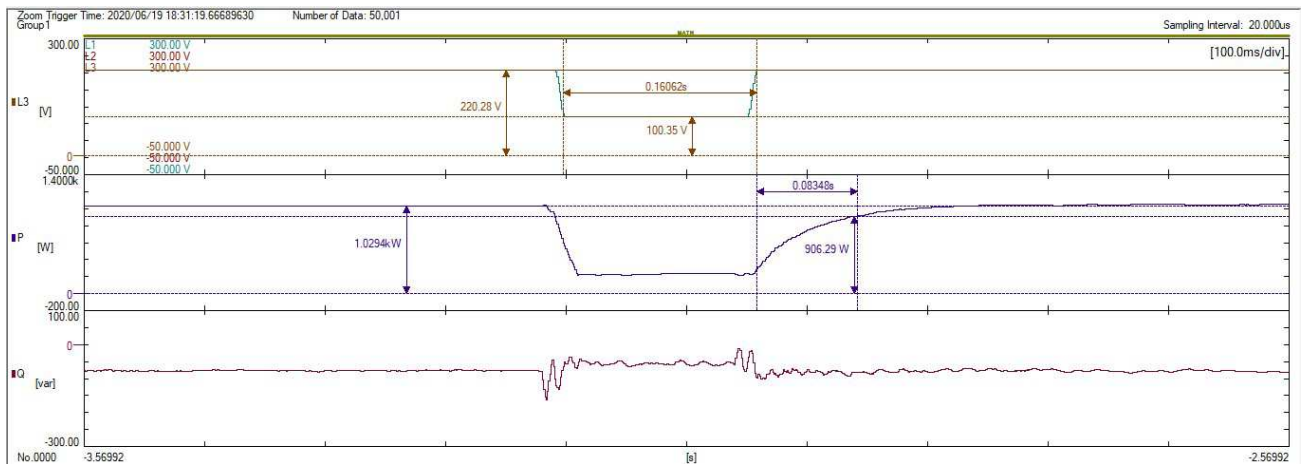

L1 phase-ground faults graph at 10%P_n: 0-0.049U_n

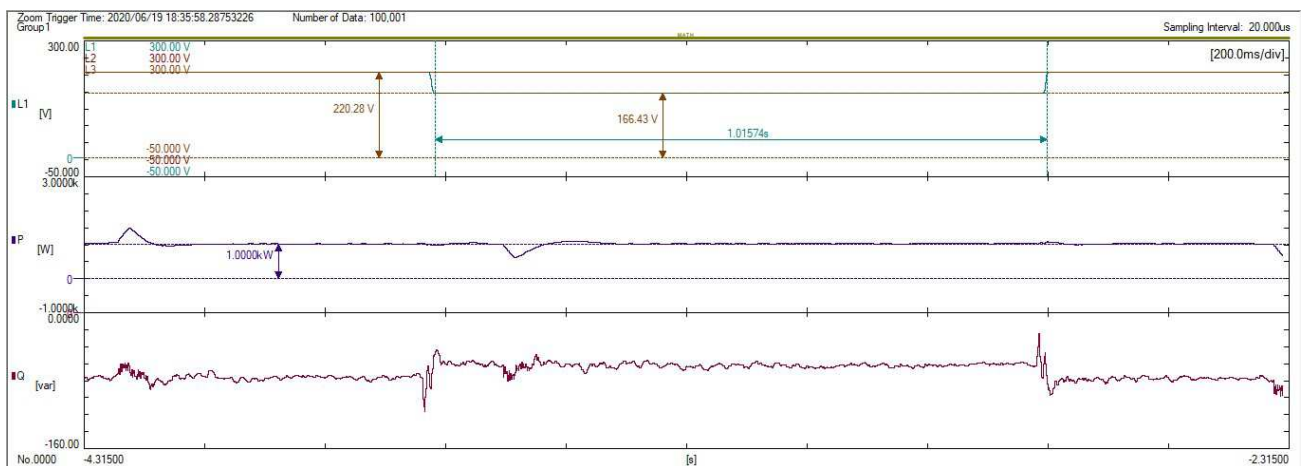



Annex No. 1

Test equipment list



Date(s) of performance of test: 2020-03-20 to 2020-07-07

Equipment	Internal No.	Manufacturer	Type	Serial No.	Last Calibration
Power Analyzer	A4080002DG	YOKOGAWA	WT3000	91M210852	2019-09-12
AC Source	A7040019DG	Chroma	61512	61512000439	Monitored by Power Analyzer
AC Source	A7040020DG	Chroma	61512	61512000438	
DC Simulation Power Supply	A7040015DG	Chroma	62150H-1000S	62150EF00488	
	A7040016DG	Chroma	62150H-1000S	62150EF00490	
RLC Load	A7150027DG	Qunling	ACLT-3803H	93VOO2869	
Eight Channel Digital Phosphor Oscilloscope	MY57231269	KEYSIGHT	DSOX3014T	HK200110222	2020-01-14
Four Channel Digital Phosphor Oscilloscope	A4089003DG	Tektronix	DPO4104B	C010624	2019-09-24
Oscilloscope probel	A1490008DG	YOKOGAWA	701901	//	2019-09-20
	A1490009DG	YOKOGAWA	701901	//	2019-09-20
	A1490010DG	YOKOGAWA	701901	//	2019-09-20
Current transducer	A1060008DG	YOKOGAWA	CT200	1130700017	2019-09-12
	A1060009DG	YOKOGAWA	CT200	1130700019	2019-09-12
	A1060010DG	YOKOGAWA	CT200	1130700016	2019-09-12



Annex No. 2

Pictures of the unit

Enclosure front view



Enclosure side view



Enclosure bottom view



Enclosure rear view

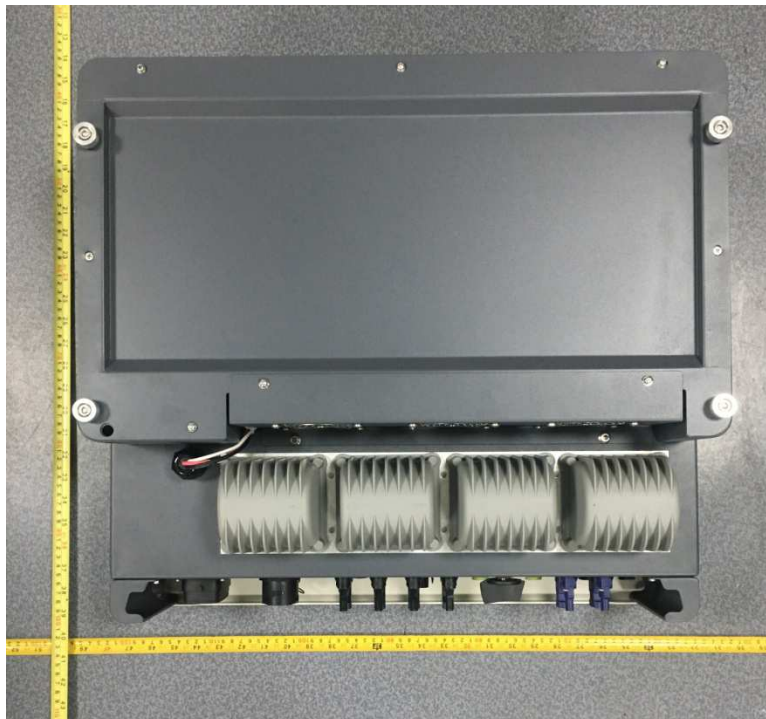

Internal view

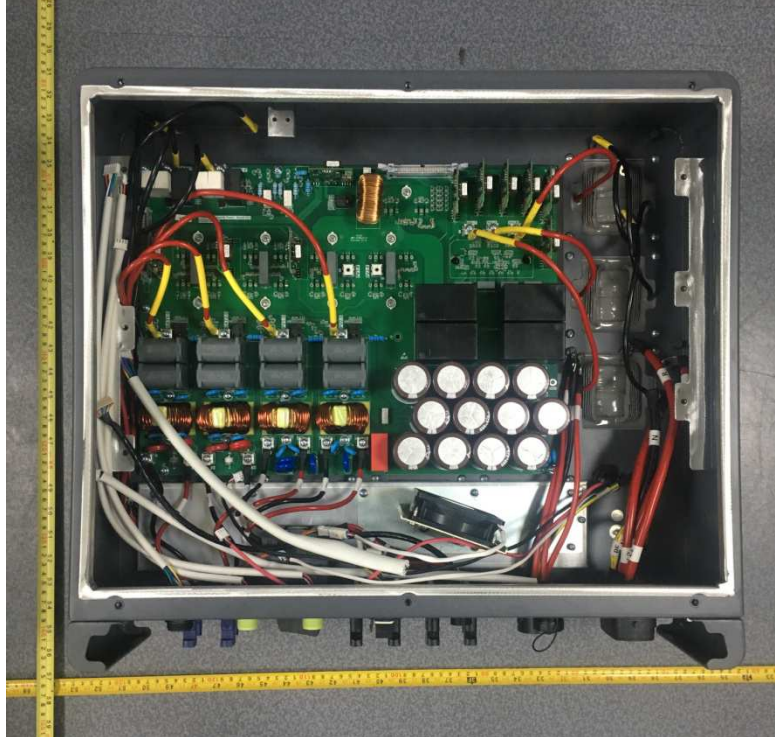

Internal view

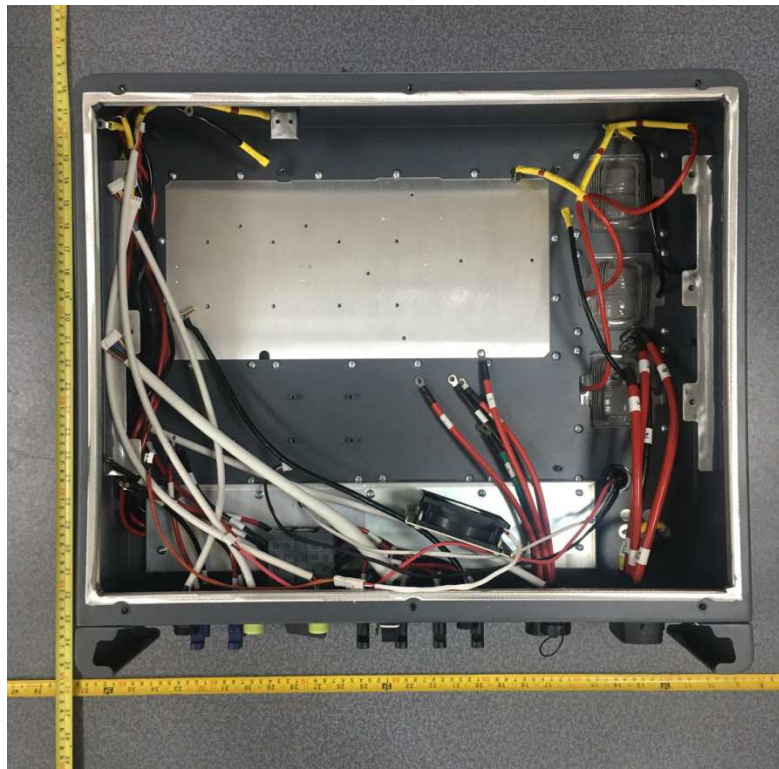

Power board-component side view



Power board-component side view

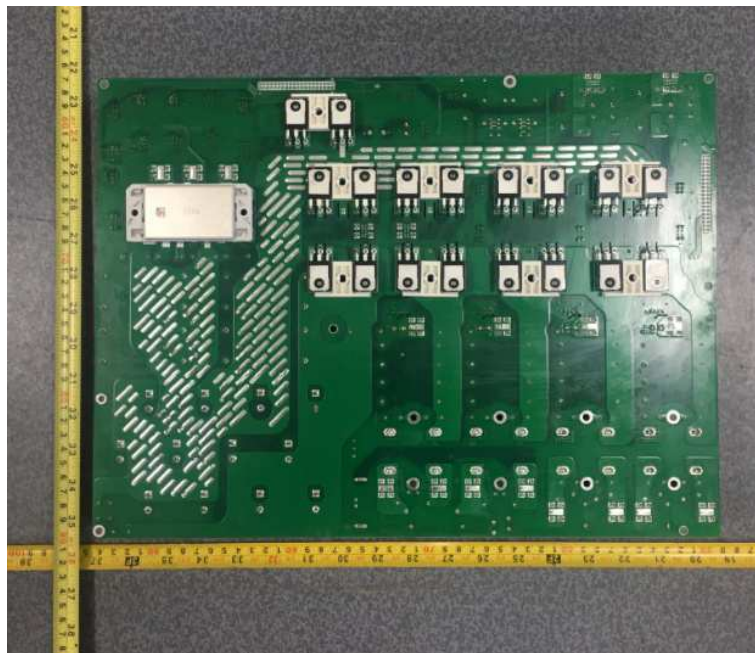

Control board solder side view



Control board solder side view



LCD display board solder side view

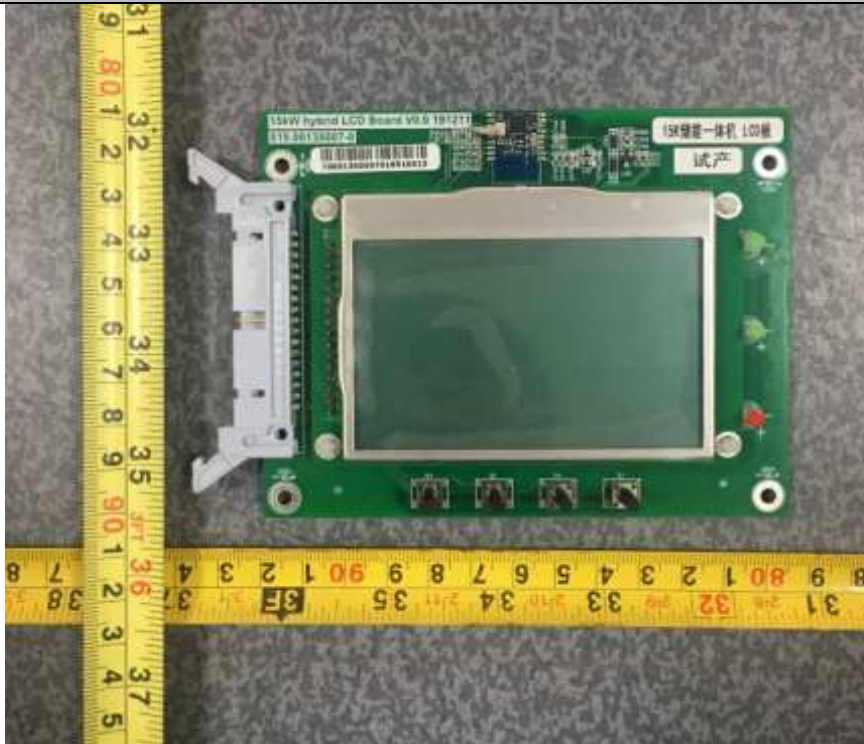

LCD display board solder side view

